



United States Department of Agriculture

Forest Service

Gen. Tech. Report WO-86a

March 2012

Groundwater-Dependent Ecosystems: Level I Inventory Field Guide

Inventory Methods for
Assessment and Planning

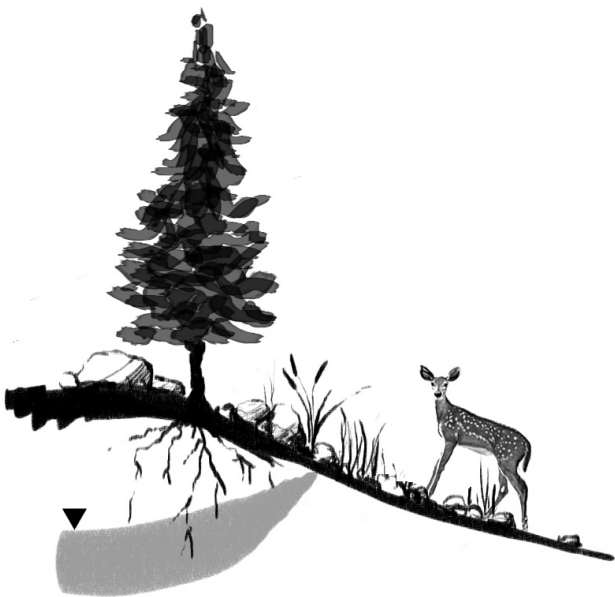



United States Department of Agriculture

Forest Service

Gen. Tech. Report WO-86a

March 2012

Groundwater-Dependent Ecosystems: Level I Inventory Field Guide

Inventory Methods for
Assessment and Planning

The U.S. Department of Agriculture (USDA) prohibits discrimination in all its programs and activities on the basis of race, color, national origin, age, disability, and where applicable, sex, marital status, familial status, parental status, religion, sexual orientation, genetic information, political beliefs, reprisal, or because all or part of an individual's income is derived from any public assistance program. (Not all prohibited bases apply to all programs.) Persons with disabilities who require alternative means for communication of program information (Braille, large print, audiotape, etc.) should contact USDA's TARGET Center at (202) 720-2600 (voice and TDD). To file a complaint of discrimination, write USDA, Director, Office of Civil Rights, 1400 Independence Avenue, S.W., Washington, D.C. 20250-9410, or call (800) 795-3272 (voice) or (202) 720-6382 (TDD). USDA is an equal opportunity provider and employer.

The information contained in this publication has been developed for the guidance of employees of the Forest Service, U.S. Department of Agriculture, its contractors, and cooperating Federal and State agencies. The Forest Service assumes no responsibility for the interpretation or use of this information by other than its own employees. The use of trade, firm, or corporation names is for the information and convenience of the reader. Such use does not constitute an official evaluation, conclusion, recommendation, endorsement, or approval of any product or service to the exclusion of others that may be suitable.

Contributors

This field guide was developed under the direction of the Groundwater-Dependent Ecosystems (GDE) Protocol Development Core Team with primary contributions from Marc Coles-Ritchie of Management & Engineering Technologies International, Inc. (METI, Inc.) and Joe Gurrieri (Forest Service, an agency of the U.S. Department of Agriculture). Chris Carlson (Forest Service) and Steve Solem (METI, Inc.) provided essential edits and guidance in the field guide development process. Other members of the Core Team, who provided detailed edits and recommendations at multiple stages of the field guide development, were (of the Forest Service unless otherwise noted): Allison Aldous (The Nature Conservancy), Devendra Amatya, Trish Carroll, Kate Dwire, Mark Gonzalez (Bureau of Land Management, U.S. Department of the Interior), and Barry Johnston.

The GDE Protocol Development Steering Team provided valuable guidance at multiple stages of the process. That team was made up of the following individuals (of the Forest Service unless otherwise noted): Leslie Bach (The Nature Conservancy), Chris Carlson (team leader), Tony Crump, Tony Erba, Russ Lafayette, Bill LeVere, Dan Neary, Mike Nevill, Andy Rorick, Linda Spencer, Cynthia Tait, and Richard Ullrich. Luke Boehnke created the figures, including invertebrate illustrations in appendix 11.

Reviews and comments were also provided by members of Technical Advisory Teams for the GDE Protocol Development project.

Pilot testing of this field guide involved dedicated individuals from the following units: Black Hills and Nebraska National Forests (Rocky Mountain Region); the Spring Mountains National Recreation Area (on the Humboldt-Toiyabe National Forest) (Intermountain Region); Inyo National Forest (Pacific Southwest Region); the Malheur, Wallowa-Whitman, and Umatilla National Forests (Pacific Northwest Region); Francis Marion and Sumter National Forest (Southern Region), White Mountain National Forest (Eastern Region); and the Fraser Experimental Forest (Rocky Mountain Research Station).

Acknowledgments

This field guide is a product of a partnership between The Nature Conservancy, Oregon Chapter, and the Forest Service to improve the awareness and management of groundwater-dependent ecosystems.

Support for development of this field guide was provided by Anne Zimmermann, Director of Watershed, Fish, Wildlife, Air, and Rare Plants and Tony Ferguson, Former Director of Minerals and Geology Management. Joel Holtrop, Former Deputy Chief for National Forest System, provided encouragement and support along with the Information Resources Decision Board in providing project funding. Operational support was provided by Patrice Janiga, Ecosystem Management Coordination (EMC) Information Assets Portfolio Manager; Mindy Martin, EMC Contracting Officer's Representative; and Jody Rose, Intermountain Region Webmaster. The project team members and leadership provided by METI, Inc., were essential for successful project management and development of the field guide.

Foundations

Many questions in the “Pre-Field Survey” and “Field Survey” portions of this field guide are based on the *Forest Service Site General: Field Guide* (USDA Forest Service 2009). Attributes that are required in Site General are noted as such.

Much of this field guide has been influenced by the foundational work of others in the fields of spring and wetland science as represented in the following protocols:

- *Field and Laboratory Operations Report for the Oregon Wetlands Study* (Magee et al. 1995).
- *Terrestrial Springs Ecosystems Inventory Protocols* (Stevens et al. 2006).
- *National Park Service Mojave Inventory and Monitoring Network Spring Survey Protocols: Level I and Level II* (Sada and Pohlmann 2006 draft).
- *Groundwater and Biodiversity Conservation: A Methods Guide for Integrating Groundwater Needs of Ecosystems and Species Into Conservation Plans in the Pacific Northwest* (Brown et al. 2007).
- *Interim Protocol, Ground-Water Resource Inventory and Monitoring Protocol, Level I Spring Ecosystem Inventory* (Gurrieri 2007 draft).
- *Assessing Proper Functioning Condition for Fen Areas in the Sierra Nevada and Southern Cascade Ranges in California: A User Guide* (Weixelman and Cooper 2009).
- *Study Plan: Sampling of the Polygons Photointerpreted for Possible Fens on the Grand Mesa-Uncompahgre-Gunnison National Forest, Colorado* (Johnston et al. 2009 draft).

Contents

Introduction	1
Business Requirements Addressed by This Field Guide	2
Relationships Between Business Requirements and Field Guide Levels	5
Targeted GDEs	8
Limitations on Use	15
Using the Level I Field Guide	17
Skills and Time Required	19
When To Sample	20
Preventing Damage to Sites	22
Pre-Field Survey Activities (in office)	23
Site Information	23
Geographic Information	26
Mapping	29
Route	31
Other Information About the Site	32
Field Survey Activities	35
Survey Information	35
Georeferencing	40
Geologic Setting	42
Images	48
Unusual Sites	52
Vegetation	52
Soil	55
Hydrology	64
Aquatic and Terrestrial Fauna	76
Natural and Anthropogenic Disturbance	77
Management Indicator Tool	82

Post-Field Survey Activities (in office)	105
Obtain or Verify Data	105
Laboratory Analyses.....	105
Implement Data Management and Interpretation Procedures	106
Validate and Confirm Management Indicator Tool Entries	106
Analyze and Evaluate Collected Information.....	106
Glossary	107
References	115
Appendix 1. Order of Data Collection	119
Appendix 2. Job Hazard Analysis	121
Appendix 3. Field Forms	129
Appendix 4. Site Protection Guidelines.....	141
Appendix 5. Groundwater-Dependent Ecological Systems Described in NatureServe	143
Appendix 6. Equipment List	147
Appendix 7. Secondary Lithology	151
Appendix 8. Landform.....	161
Appendix 9. Plant Labels	165
Appendix 10. Measurement of Discharge at Springs and Wetlands	167
Appendix 11. Identification of Freshwater Invertebrates	181

Introduction

This Level I inventory field guide describes a national protocol to supply data used in project identification and planning. Data collected through this field guide serve as the basis for the assessment of project and activity effects on, and the identification of project-level design and mitigation measures for, a specific set of groundwater-dependent ecosystem (GDE) types.

This Level I field guide includes procedures for collecting a narrower array of data attributes and less detail for some data attributes than the companion Level II field guide (GTR-WO-86b). This Level I field guide is intended to document the location, size, and basic characteristics of a site during a relatively short 2-hour site visit by a trained field crew. The Level II field guide is intended to more comprehensively characterize the vegetation, hydrology, geology, and soils of GDE sites and typically would require 4 to 8 hours at the field site by a crew of specialists.

If inventory or monitoring of specific species or communities is the goal, then a more detailed and/or targeted set of methods should be used.

Specific examples of what this field guide is designed to be used for include the following:

- Determining the location and extent of GDEs within an area (as long as appropriate site selection process is used).
- Qualitatively characterizing GDEs within an area (as long as appropriate site selection process is used).
- Determining if GDEs may be affected by proposed actions or activities.

If the objective is to monitor certain conditions of a GDE, then it will be necessary to develop and use a more detailed and site-specific Level III protocol. This Level I field guide, however, can be used as a starting point for the development of a site-specific Level III protocol that will meet the management needs of a particular situation. Assistance with the development of Level III protocols is available from the National Groundwater Technical Team.

Business Requirements Addressed by This Field Guide

Pressure on National Forest System (NFS) lands to supply the water, minerals, and energy needed to meet societal needs is intensifying. In addition, wildland fire management, hazardous fuels reduction, invasive species control, livestock grazing, mineral extraction, road and trail management, and ecological restoration activities also affect GDEs. Accurate and consistent information regarding GDEs and their condition is critical to making decisions about and implementing a wide variety of mission responsibilities of the Forest Service, an agency of the U.S. Department of Agriculture (USDA). This Level I field guide is designed to collect accurate and consistent information regarding the location of GDEs and their condition. Data collected are essential to informed decisionmaking associated with the agency's mission responsibilities supported by broad- and mid-scale assessments and land and resource management planning. The Level II GDE field guide should be used to collect data needed to inform project-level decisions and activity administration affecting GDEs.

Effective resource management requires a clear understanding of the underlying business requirements for practicing conservation. In some instances, policy and direction limit management's ability to respond to identified needs; in others, they create an affirmative obligation for the agency to take action to conserve or protect resources and public safety. Business requirements stem from two primary sources: (1) regulatory and policy requirements, and (2) management questions and concerns associated with land and resource management plans and ongoing or proposed projects/activities (see table 1).

Across the NFS, legal requirements and management issues are highly variable, so it is difficult to define a discrete set of business requirements applicable to all NFS lands. In several instances, laws and regulations provide the opportunity for States and tribes to establish additional requirements (these could be statutory or rule based) for the protection of resources associated with GDEs. This situation creates an even more complex set of management requirements. This Level I field guide, therefore, is designed to allow for local additions within an established national framework.

Information used to identify management requirements was gleaned from the Forest Service Directives System, Forest Service Manual (FSM) 2880 and the "zero chapters" of FSMs 1900, 1940, and 2500 were the primary sources consulted.

Table 1.—*Business requirement sources.*

Management requirements	Management questions
<ul style="list-style-type: none"> • Laws—Establish Forest Service authority and procedural requirements for managing GDEs. • Regulations—Establish the processes and policy for conducting land and resource management activities affecting GDEs. • Executive Orders and Presidential Directives—Specify procedures and requirements applicable to all Government agencies for the management and protection of GDEs and associated resources. • Departmental policy—Establishes procedures and policies for USDA agencies responsible for or potentially affecting GDE resources. • Agency policy—Establishes agency-specific procedures for regulatory requirements if not addressed directly through other means. 	<ul style="list-style-type: none"> • Land management plans—Establish desired outcomes (goals and objectives), standards and guidelines, and monitoring requirements. Plans include: <ul style="list-style-type: none"> ▪ Ecological context—Are ecological systems functioning and disturbance processes operating within the natural or desired range of variation? Are human pressures or changes in ecological systems inducing changes to the ecological context in which species reside? ▪ Species context—Are habitat relationships or ecological factors affected by management creating risk to species persistence? • Resource or area plans—Refine interpretations and requirements for specific resources or areas. • Monitoring—Includes: <ul style="list-style-type: none"> ▪ Implementation—Are projects and activities being implemented as designed? ▪ Effectiveness—Are mitigation measures, best practices, and design features effective in mitigating anticipated impacts? ▪ Validation—Are conservation actions achieving desired outcomes?

Management requirements applicable to inventory and monitoring of GDEs fall into three groups:

1. GDE resource management—The importance of GDEs, and their ability to sustain both ecological systems and species dependent on groundwater resources, is evident in most national forests and grasslands. The collection of requirements related to the management of water and water uses, and the conservation of threatened, endangered, and sensitive species that rely upon these areas, is further evidence of their importance. Protection, conservation, and restoration of GDEs are often key aspects of decisionmaking on NFS lands and a foundation for many land management plans. Inventory and monitoring of GDEs are described in FSM 2880.

Because of the State-by-State variability associated with water rights and uses within the NFS, no attempt has been made to summarize such requirements that apply below the national level as part of this effort. Readers are encouraged to consult FSM 2540 and appropriate regional and forest supplements to that chapter to review those requirements.

2. Planning and environmental compliance—Policy and procedures for land management planning and environmental compliance activities are outlined in FSM 1920 and 1950, respectively. Depending on the “vintage” of the land and resource management plan for an NFS administrative unit, different requirements apply. Field users are encouraged to consult their appropriate land management plans and the National Environmental Policy Act (NEPA) decision documents associated with individual uses, activities, and authorizations to determine specific design and monitoring requirements.

3. Resource information management—Forest Service Natural Resource Manager (NRM) resource information systems, such as NRM-Natural Resource Information System (NRIS), NRM-Infrastructure (INFRA), and NRM-Automated Lands Program (ALP), provide agencywide data systems that comply with departmental and agency requirements. NRM applications must be used to store GDE data collected under this Level I field guide. NRM applications also provide standard analysis and evaluation tools supported by the data collection methods described in this field guide.

Management requirements applicable to GDE inventory and monitoring can be summarized into the following general points:

- Support an affirmative agency obligation to **protect, conserve, and restore** waters, watersheds, and listed wildlife and plant species and their habitats, and to conserve biological diversity.
- **Assess and disclose environmental effects** associated with ongoing and proposed actions and activities, including using monitoring data to identify needed adjustments to management practices.
- **Use the best available information and science** to support agency decisionmaking. Collect and maintain resource data with known data standards and data quality for use in agency decisionmaking processes. Provide for information security.

A detailed review of more than 100 statutes and policies that establish management requirements addressed by this effort is documented in *Groundwater Dependent Ecosystems Inventory and Monitoring Business Requirements Analysis* (v5.2, January 30, 2010) and is available for review at <http://www.fs.fed.us/geology/groundwater.html>.

Relationships Between Business Requirements and Field Guide Levels

Because of the variety of situations encountered on NFS lands, it is essential to develop a field guide “package” consisting of integrated modules or components that can be matched to a local unit’s business requirements and needs. Using different inventory and monitoring “intensity levels,” which herein correspond to field guide levels, supports this functionality.

A relationship exists between the types of management requirements and questions being addressed and the data needed to address those questions. The amount of effort or “intensity” of inventory and monitoring can be categorized into three levels. Table 2 describes the level of effort and focus of these levels.

Table 2.—Descriptions of GDE inventory and monitoring intensity levels.

Inventory and monitoring intensity level	Description
Level I	Conducted to characterize GDEs qualitatively within an administrative unit or management area. GDE location and extent are spatially referenced . Serves as the basis for determining when GDEs may be affected by proposed actions or activities or landscape scale change.
Level II	Serves as the foundation for assessment of project and activity effects and identification of design measures . Describes major attributes including the following: hydrogeologic setting, aquatic habitat, aquatic and wetland flora and fauna, and site-affecting disturbances. Can be used to determine ecological significance of the GDE and associated resources. Can also be used as a foundation for designing a long-term monitoring plan.
Level III	Usually conducted in relation to monitoring a major activity or set of activities affecting GDEs and their characteristics. Compiles highly quantitative information that describes spatial and temporal variation in physiochemical characteristics of GDEs. Often used in the administration of projects or activities and, therefore, is highly site specific.

To provide flexibility and ensure appropriate use of the GDE field guides, the relationship between business requirements (why data are collected) and inventory and monitoring field guides (how data are collected) must be clearly described and understood. The relationship between business requirements and GDE inventory and monitoring field guide (intensity) levels is illustrated in figure 1.

The number of management questions considered and the level of detail needed to address these questions increases with the inventory and monitoring intensity level. Each of the boxes in figure 1 represents a grouping of management requirements. The level of detail and resolution for data elements needed to support the business requirements increases from Level I to Level III. For example, the types of information collected in Level I for vegetation would be more general than those collected in Level II, which would likely be more general than those collected in Level III, depending on the particular management requirements for which

the Level III protocol was developed. Specific management questions have been identified and associated with business requirements as part of the GDE Business Requirements Analysis.

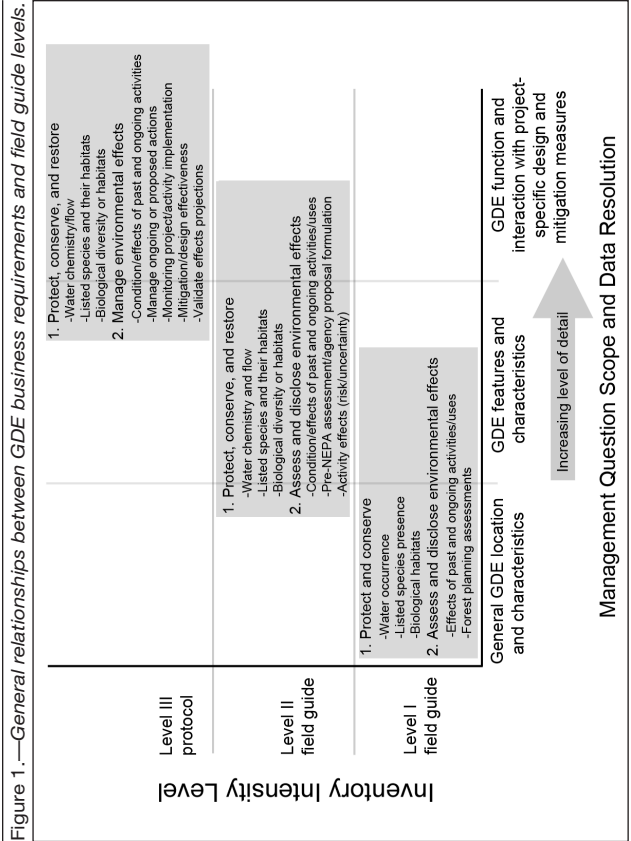

Targeted GDEs

Although many different types of GDEs exist, not all are targeted for this field guide. GDEs are ecosystems that are supported by groundwater, which include springs and seeps, cave and karst systems, phreatophytic ecosystems, and, in many cases, rivers, wetlands, and lakes. This field guide was developed to focus on a subset of nonmarine GDEs, specifically springs and groundwater-dependent wetlands (such as fens) as illustrated in figure 2.

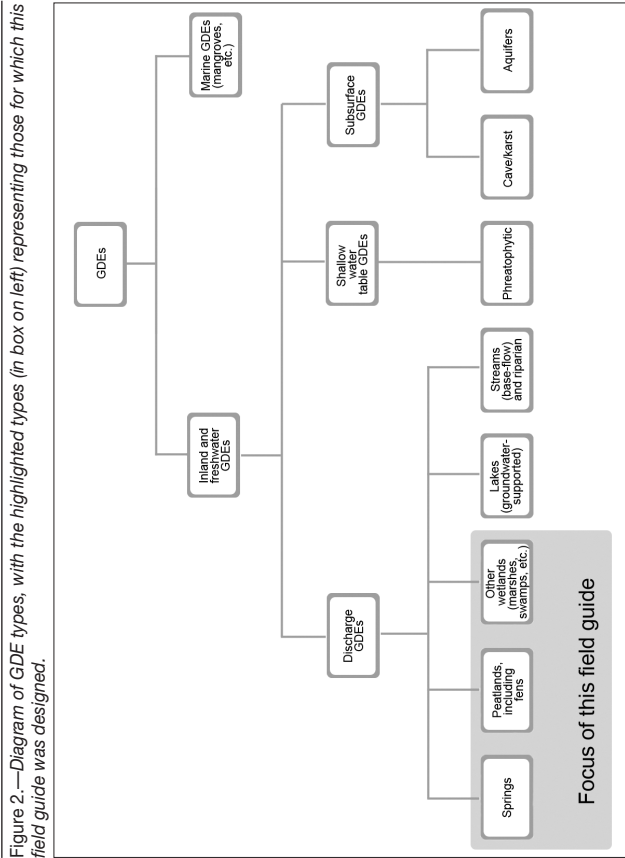

Although this field guide is not intended specifically for other types of GDEs (lakes and ponds, streams and hyporheic zones, riparian areas, phreatophytic systems, or marine systems), parts of this field guide could be used to inventory or monitor these systems as well.

In general, where groundwater intersects the ground surface, plants and animals that are supported by access to that groundwater will occur, hence the term “groundwater-dependent ecosystems.” In some cases, groundwater emerges at a point location, usually called a spring or seep, depending on the quantity of water available. Herein the term “spring” will be used to include both springs and seeps. Springs are always GDEs. In the case of wetlands supported by groundwater, often there is not a single point where the groundwater flows or emerges at the surface; rather, it usually emerges in a more diffuse manner across a large area. In some wetlands, however, springs emerge within the wetland, or a complex of wetlands and springs is present across an area. In many cases, groundwater-dependent wetlands, such as fens, are simply springs covered by unconsolidated material (such as glacial deposits, pumice, colluvium) that become saturated to the surface. Because an indistinct boundary exists between springs and wetlands dependent on groundwater discharge, a single field guide was developed for these systems. Groundwater emerging at the ground surface is the common thread that links these features and their associated ecosystems.

It is important to recognize that some wetlands are not supported by groundwater, but are formed from water that originates exclusively from precipitation and associated surface runoff. Such wetlands are called “ombrogenous” hydrological systems (National Wetlands Working Group 1997). The meaning of the term ombrogenous is “rain fed” according to Mitsch and Gosselink (2007). Ombrogenous wetlands are not the focus of this field guide, although the field guide may have components that could be used to evaluate ombrogenous wetlands.

This field guide is intended for those wetlands that are supported by groundwater that has come in contact with mineral soils or bedrock. Such wetlands are called “minerogenous” hydrological systems (National Wetlands Working Group 1997) or “minerotrophic peatlands” (Mitsch and Gosselink 2007). Minerogenous wetland systems are normally situated at positions in the landscape lower than adjacent terrain, such that water and transported mineral elements are introduced by groundwater.

Minerogenous hydrological systems have a strong linkage with the physical and chemical nature of the geological environment and generally involve the regional groundwater system. They are not restricted by local climatic conditions because the groundwater source is generally sufficient to maintain soil saturation and, therefore, wetland processes. By contrast, ombrogenous hydrological systems (or ombrotrophic peatlands, as described by Mitsch and Gosselink (2007)) are not dependent on groundwater and are highly restricted geographically because of local climatic conditions. In arid and semiarid regions, many wetlands are supported by groundwater. In humid regions, distinction of groundwater support of wetlands becomes more difficult. Nevertheless, many wetlands in humid regions are highly groundwater dependent.

Because it is not always easy to verify a wetland's dependence on groundwater, a site-specific assessment is necessary. One source of information to help determine groundwater dependence is a publication by The Nature Conservancy (Brown et al. 2007), which includes decision trees for determining groundwater dependence, such as the one for wetlands, which is adapted for this Level I field guide in box 1.

In summary, this Level I field guide is intended for the inventory and monitoring of a subset of GDEs, specifically springs and groundwater-dependent wetlands (described in table 3). The primary basis for determining which systems to include in the GDE field guide is hydrology, specifically the primary water source. This field guide provides a very general classification of wetlands to indicate which types of wetlands are covered (fig. 2 and table 3).

Box 1

Decision Tree for Identifying Groundwater-Dependent Wetlands

(based on Brown et al. 2007, with modifications for this field guide)

Answer the questions in sequence. A **bold** answer indicates likely groundwater dependence, and subsequent questions need not be answered.

1. Is the wetland seasonal?
Yes—Low likelihood of groundwater dependence
No—Go to next question
2. Does the wetland occur in one of these landscape settings:
(a) slope break, (b) intersection of a confined aquifer with a slope,
(c) stratigraphic change, or (d) along a fault?
Yes—High likelihood of groundwater dependence
No—Go to next question
3. Is the wetland associated with a spring or seep?
Yes—High likelihood of groundwater dependence
No—Go to next question
4. Does the wetland have signs of surface inflow?
No—High likelihood of groundwater dependence
Yes—Go to next question
5. Are the wetland soils organic, muck, or peat?
Yes—High likelihood of groundwater dependence
No—Go to next question
6. Is the wetland saturated even after surface inputs become dry and during extended periods with no precipitation?
Yes—
Are the wetland soils clay, hardpan, or impermeable?
No—High likelihood of groundwater dependence
Yes—Low likelihood of groundwater dependence
No—Low likelihood of groundwater dependence

Table 3.—Important GDE characteristics and the GDE types covered by this field guide.

Characteristics	Springs	Peatlands, including fens (groundwater dependent)	Other wetlands (groundwater dependent)
Hydrology	Completely groundwater dependent	Minerotrophic; always groundwater dependent	Minerotrophic; depend on groundwater, precipitation, and sometimes stream inflow
Water table position	At ground surface or, for artesian, a piezometric surface above the ground surface	At or slightly below surface, or piezometric surface above the ground	Above or below ground surface; can fluctuate dramatically; can have periodic standing water
Soils and peat or muck depths	Mostly mineral soils; sometimes a small accumulation of peat	Accumulation of peat or muck up to several meters; little or no mineral soil within plant-rooting zone for fens	Usually little or no peat or muck accumulation; sometimes wood-rich peat
Redox conditions ^a	Oxic to anoxic depending on geochemistry and residence time of water in aquifer	Anoxic slightly below the surface, leading to the accumulation of peat or muck	Temporary soil anoxia during times of high water table or standing water
Water movement within GDEs	Standing or flowing water	Slow to imperceptible flow on surface	Periodic standing or flowing water

^a Redox (short for REDuction-OXidation) conditions describe a key chemical characteristic in hydrologic systems that controls the availability of many elements and the propensity of the system to support the accumulation of organic matter, such as peat and muck. At the ground surface, redox conditions are often controlled by the availability of oxygen.

Table 3.—Important GDE characteristics and the GDE types covered by this field guide. (continued)

Characteristics	Springs	Peatlands, including fens (groundwater dependent)	Other wetlands (groundwater dependent)
Water chemistry	Highly variable; from acidic to basic, temperatures vary, can be thermal, can be saline	Minerotrophic, acidic (poor fens) to basic (rich fens); can be iron rich or calcareous	Highly variable, from acidic to basic
Vegetation	Graminoids, forbs, shrubs, bryophytes, and trees; variable amount of wetland vegetation	Bryophytes, graminoids, and low shrubs; lichens; sometimes trees; always wetland vegetation	Tall woody plants and forbs (swamps) or emergent graminoids and floating aquatic macrophytes (marshes); mostly wetland vegetation

Springs

Springs are GDEs where groundwater discharges at the ground surface, often through complex subsurface flow paths (Stevens and Meretsky 2008). Where a spring emerges from the ground, there are communities of plants and animals that depend on that water. There are many different types of springs. Spring-type descriptions in this field guide are from Springer and Stevens (2009). Most spring types—such as outflows from caves, helocrenes, hypocrenes, hillslope springs, limnocrenes, fountains, and rheocrenes—can be characterized using this field guide.

Wetlands Dependent on Groundwater (including peatlands)

The Level I field guide recognizes that a variety of wetland types are dependent on groundwater, with many different regional characteristics, classifications, and names. It also affirms that groundwater dependence spans a continuum from completely groundwater dependent to not dependent, with varying levels of dependence between these end members. In this field guide, however, there is no need to distinguish among these different types of groundwater-dependent wetlands. For the purposes of this sampling field guide, all are considered GDE wetlands, including fens, marshes, swamps, wet meadows, and depression wetlands.

This field guide, however, does distinguish in some ways between fens (i.e., wetlands that have accumulations of peat or muck) and groundwater-dependent wetlands that do not have peat or muck accumulations. Peat and muck are partially decayed plant material that accumulates under saturated conditions where there is little oxygen to facilitate decomposition.

Some names for wetland types apply both to sites dependent on groundwater and to others that are maintained by surface water. The surface-water supported wetlands, regardless of their name, are not the focus of this field guide, although the methods described here may be useful to characterize some of them.

Another way to evaluate these types of wetlands is with the criteria for wetland delineation used by the U.S. Army Corps of Engineers (1987).

Limitations on Use

This field guide is not intended to be used for evaluating some specific nonmarine GDEs:

- Groundwater-dependent lakes and associated riparian areas.
- Base-flow streams and associated riparian areas.

Because of the distinct characteristics of those systems, it is not practical to include them in this field guide. It is expected that other field guides will address those systems, although they may not focus on groundwater conditions and processes. The Forest Service is also developing a guide to characterize and monitor riparian areas.

In addition, some wetland systems that look similar to GDEs, but are not dependent on groundwater, are not specifically targeted by this field guide:

- Bogs.
- Insurgences and sinkholes in karst areas.
- Pocosins—a type of bog in the Southeastern United States (described in Richardson 2003).
- Carolina Bays of the southeastern U.S. Coastal Plain (described in Sharitz 2003).
- Other wetlands not supported by groundwater.

Because of the similarities between these systems and GDEs, this GDE field guide may have some utility for inventorying and monitoring certain components of those systems.

GDE types that would be difficult to sample with this (and perhaps any) field guide include geysers, gushets, and hanging gardens. This field guide is not designed for underground sampling (e.g., in caves), although it would be appropriate to use for sampling the surface outflow from caves. Springs that include large open water areas (large exposure springs and large limno-crenes) could involve substantial safety concerns and would be difficult to comprehensively sample with this field guide. They require limnological sampling techniques, which are beyond the scope of this field guide.

Settings where this field guide has not been tested include tropical, subtropical, arctic, subarctic, tundra, and permafrost areas, which are beyond the scope of this field guide.

Using the Level I Field Guide

The Level I field guide describes specific procedures for field data collection for select GDEs; however, a number of important activities precede and follow field data collection. In fact, only about one-half of the expected total cost for implementing this field guide is associated with field data collection. The remainder comes from establishing the objectives; selecting an appropriate inventory or monitoring design; training; providing quality assurance and control; providing project administration and data entry; and, most importantly, analyzing and evaluating the information collected. Significant cost savings associated with field data collection can be obtained by spending time “data mining” before the field activities.

The recommended sequence of activities for implementing this field guide is represented in figure 3 and described in this section and in appendix 1.

Figure 3.—Recommended approach for successfully using this field guide.

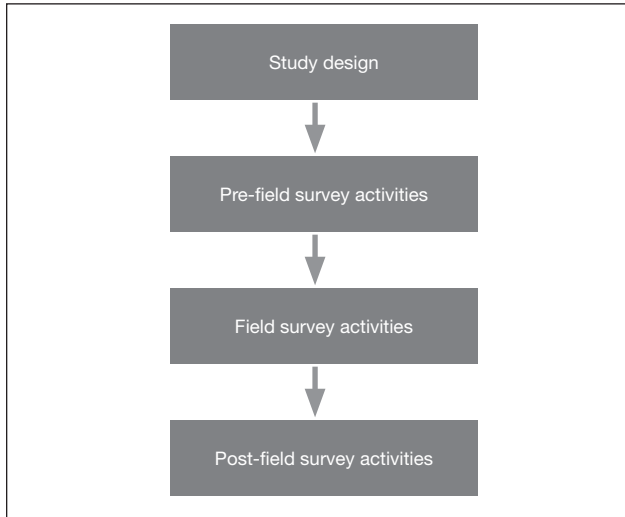

1. Study design—Developed by user (not described in detail in this field guide).

- a. Identify management questions and set inventory and monitoring objectives.
- b. Determine the area of interest and selection of sites—systematic, stratified, or random design, etc.
- c. Create the sampling and remeasurement schedule.
- d. Identify the relationship to other inventory and monitoring programs and data.
- e. Coordinate with other agencies, tribes, States, and Forest Service units.
- f. Develop quality assurance and control procedures, including training and data management.

2. Pre-field survey activities—

- a. Gather and review background information about sites, which is obtained in the office with focus on existing maps and remote sensing data (data mining).
- b. Establish field logistics and plan for site access, including travel and access restrictions. Conduct a Job Hazard Analysis, or JHA (appendix 2).
- c. Interpret available map and remote sensing images.

3. Field survey activities—

- a. Use the “Field Survey Activities” part of this field guide to conduct data collection. Data can be collected on paper field forms (see appendix 3) or with a field data recorder (personal data assistant or personal data recorder).
- b. Apply Management Indicator Tool (on site).

4. Post-field survey activities—

- a. Obtain or verify data based on location information obtained in the field.
- b. Gather laboratory analyses of samples and specimens.

- c. Implement data management and interpretation procedures.
- d. Validate and confirm Management Indicator Tool entries.
- e. Analyze and evaluate collected information (not described in detail in this field guide).

Skills and Time Required

A broad set of skills is necessary to conduct the sampling outlined in this field guide, which means that several specialists will be needed to collect good-quality data. The skills required are summarized in the following list:

- Office.
 - Geographic Information System (GIS), map interpretation.
 - Data acquisition—from data warehouses, etc. (which will likely take a number of days to accomplish).
 - Logistics—transportation, equipment, access, safety, etc.
 - Data entry.
- Field—Botany.
 - Understanding of basic wetland plant ecology.
 - Familiarity with regional flora and proficiency in identifying common wetland plant species. Capable of sight recognition of dominant species to the level of genus and species, provided plants are at the proper phenological stage, or capable of sight recognition of dominant species to the family, and proficiency in keying in the field.
 - Ability to collect and press plant specimens so that they will be suitable for later identification or verification.
- Field—Animals.
 - Familiarity with quantitative and qualitative methods of sampling for aquatic macroinvertebrates.

- Field—Hydrology/Hydrogeology.
 - Ability to measure flows and water quality.
 - Ability to describe the hydrogeologic setting of the feature, including aquifers, rock types, geologic structures, and groundwater flow system.
 - If monitoring wells or piezometers are to be installed, the ability to install, survey, and monitor them.
- Field—Soils.
 - Ability to describe the soils at a site (by augering soil cores, digging pit, or other means).
 - Ability to determine soil texture by feel.
 - Familiarity with standard soil nomenclature, soil stratigraphy, soil morphology, and USDA Natural Resources Conservation Service (NRCS) soil taxonomy.
 - Ability to interpret soil features, particularly hydric soil features, and infer soil processes within a landform setting.

With a team of a few (probably two or three) people who have the skills previously outlined, it is anticipated that the field data collection described in this field guide will take about 2 hours to complete.

When To Sample

No time is ideal for sampling all the attributes described in this field guide. The pros and cons to sampling at different times of the year are summarized here.

Winter

- Hydrology—Good time to determine base flow; very difficult to sample water table in deep snow or when ground is frozen. (In some settings, groundwater discharge prevents ground from freezing.)
- Soil—Very difficult to sample soils in deep snow or when ground is frozen. (In some settings, groundwater discharge prevents the ground from freezing.)
- Vegetation—Very difficult to identify plants and to quantify their abundance.

- **Miscellaneous**—Might be difficult to access some sites (because of snow). In warmer settings, winter might be a time to avoid excessive heat; there would probably be less disturbance to the site, such as trampling, as a result of field guide implementation. Winter use by herbivores can be observed.

Early in Growing Season

- **Hydrology**—Hydrology might be highly influenced by weather events (such as snowmelt, high runoff, or rain), and water chemistry measurements may be biased by spring runoff.
- **Soil**—Soil can generally be sampled.
- **Vegetation**—Difficult to identify plants and to quantify their abundance.
- **Miscellaneous**—Access may be a problem for some sites.

Middle of Growing Season

- **Hydrology**—Good time to measure water table, although flow and water table could be influenced by weather events (such as rain).
- **Soil**—Good time to do soil sampling.
- **Vegetation**—Good time to identify plants and to quantify their abundance.
- **Miscellaneous**—Most sites are accessible. Livestock use can be observed.

Late in Growing Season

- **Hydrology**—Good time for determining groundwater influence, although water tables may be lower than they are in midseason, making some water chemistry measurements difficult.
- **Soil**—Good time for sampling whole soil profiles.
- **Vegetation**—In general, a good time to identify most plants, but some plants may have reached senescence, making identification difficult.
- **Miscellaneous**—Good time for observing or measuring effects of use by herbivores.

The weather conditions always need to be recorded and considered when evaluating the data. For example, rain can alter pH and conductivity and raise the water table.

Preventing Damage to Sites

Springs, fens, and other GDE wetlands are relatively uncommon on the landscape in most areas and are also vulnerable to impacts from activities associated with data collection. Small GDE sites are particularly vulnerable because the impacts are concentrated over a small area. Appendix 4, Site Protection Guidelines, outlines specific suggestions for minimizing damage to the plants, soils, and hydrologic processes of these valuable ecosystems.

Pre-Field Survey Activities (in office)

This section explains what information should be gathered or acquired in the office before going out to the field. This information can be compiled in the office using existing data in Forest Service NRM applications and through map and remote sensing (including photo) interpretation. Some of this information might be updated after the site visit, when field-determined coordinates for the site can be plotted on the map.

Obtain information necessary to address some of the Management Indicator Tool statements before going to the site. Review the applicable land resource management plan to determine whether the plan recognizes and provides direction for conservation and protection of the site. Identify whether any management activities have taken or are currently taking place at the site. Also, identify if any authorized uses are located at the site and the terms and conditions of those authorizations.

Site Information

Site Identification

Description—The site identification (ID) is a unique identifier for each GDE site. It is useful for managing the data in the field and in a database. The same site ID should be used for different sampling events at the same site (such as monitoring over time).

Source—The site ID may be obtained from the NRM-INFRA Database or the NRM-NRIS Water Rights and Uses database. Units may have created their own site IDs in the past. If multiple site IDs exist, then choose the one that best represents the site and meets the management needs for which the field guide is being implemented (e.g., if the field guide implementation is being done to assess effects from water withdrawals, then select the existing NRM-NRIS Water Rights and Uses site ID). If no site ID exists (or it is unknown), then create a site ID. It is highly recommended that the numbers for the region, forest, and district form the beginning of the site ID (as recommended in Site General). An example would be “040213 Johnson’s Spring.” Some site IDs may be only numeric and descriptive text would be in the site name (see the following description). If the site ID contains descriptive text, then the site name may include some of the same text.

Site Name

Description—The site name is a descriptive name for the site, such as the common name of a spring or wetland. A portion or the entire text of the site name might also be contained in the site ID.

Source—The site name can be obtained from the following:

- Maps—
 - U.S. Geological Survey (USGS) quadrangle map (these names are also listed in the USGS Geographic Names Information System).
 - Forest Service primary base series maps, which are the Forest Service version of the USGS quad.
- Management plans, such as a forest plan, project plan, or allotment plan, or existing authorizations that specify the site by name.
- If no site name exists in the sources previously listed, create a descriptive name that is representative—and respectful—of the site. It is helpful if this name is unique.

Project Name

Description—The project name is a descriptive term for the field guide implementation effort. A project can be a data collection activity containing multiple data collection sites guided by a specific purpose. Multiple sites can be within the same project. (This is a required field in Site General.)

Source—The project team will create this name.

Purpose

Description—The purpose describes the reason the site is being sampled. A list of values is included from Site General. (This is a required field in Site General.)

Source—Select one or more purposes from the following list:

- Area assessment.
- Analysis for recreation impacts—human or stock.
- Threatened and endangered species animal habitat analysis.
- Big game habitat evaluation.

- Ecosystem analysis.
- New ecosystem classification or successional analysis.
- Ecological unit inventory plot.
- Existing vegetation map unit.
- Fire effects or fire history plus fuels.
- Forest plan revision.
- Previous habitat type classification data.
- Integrated multiresource inventory/monitoring.
- Invasive plants inventory.
- Mining claim examination.
- Mining or oil/gas rehabilitation monitoring.
- Threatened and endangered plant species habitat analysis.
- Correlation with permanent timber management plot.
- Range allotment inventory.
- Correlation with regeneration exam/stake rows.
- Range monitoring (i.e., reading, trend, utilization).
- Resource Natural Area and special interest area analysis.
- Research plots.
- Correlation/verification for spectral data/Landsat.
- Correlation with stand exam.
- Correlation with soil survey.
- Vegetation inventory.
- Watershed analysis.
- Wilderness ecology inventory/monitoring.
- General wildlife habitat.
- Watershed inventory.
- Watershed monitoring.
- Operating mine monitoring.
- Oil/gas development.
- GDE inventory or monitoring.
- NEPA.
- Administrative study site.
- Research.
- Water uses and needs inventory.
- State adjudication.
- Determination of waters of the United States.
- Other:_____.

Geographic Information

State

Description—The U.S. State(s), possession(s), or territory where the site is located.

Source—Forest Service NRM-ALP database.

County

Description—The county or counties in which the site is located.

Source—Forest Service NRM-ALP database.

Land Status

Description—The land status where the site is located. (This is called “ownership” in Site General and is a required field.) Options include Forest Service; U.S. Department of the Interior (USDI) agencies, such as U.S. Fish and Wildlife Service and Bureau of Land Management; county government; etc.

Source—Forest Service NRM-ALP database.

Note: It is also useful to determine if the entire site and immediate area are under the jurisdiction and management of the Forest Service. A related piece of information is whether any activities or management on lands outside Forest Service jurisdiction are affecting this site. (This information will be necessary to answer questions in the Management Indicator Tool, which is toward the end of this document.)

Forest Service Region

Description—The Forest Service region(s) in which the site is located. This field is required when land status is Forest Service.

Source—Forest Service NRM-ALP database.

National Forest, Grassland, or Prairie

Description—The NFS unit(s) in which the site is located. This field is required when land status is Forest Service. (This is called “Proclaimed National Forest/Grassland” in Site General.)

Source—Forest Service NRM-ALP database.

Forest Service Ranger District

Description—The ranger district(s) in which the site is located. This field is required when land status is Forest Service.

Source—Forest Service NRM-ALP database.

Grazing Allotment Number

Description—The grazing allotment number. This is useful for projects that are focused on grazing issues.

Source—Forest Service NRM-INFRA database.

Grazing Allotment Name

Description—The grazing allotment name. This is useful for projects that are focused on grazing issues.

Source—Forest Service NRM-INFRA database.

NRM-INFRA Reference Number

Description—The NRM-INFRA database reference number has been assigned to physical structures or development. (If development occurs at the site, it should be recorded in the Forest Service NRM-INFRA database that records all structures, infrastructure investments, and use authorizations on NFS lands.)

Source—Forest Service NRM-INFRA database.

Water Right Number and Status

Description—This number is assigned to a water source by a State. The water right status is a determination of the validity of the water right that allows the holder to use it in the manner represented or prescribed. This is useful for projects that are focused on water rights issues.

Source—Forest Service NRM-NRIS Water Rights and Uses database.

Note: It would be useful to determine if there are any outstanding claims for water rights by others for this site. (This information will be necessary to complete the Management Indicator Tool, which is described later in this field guide.)

Watershed(s) Hydrologic Unit Code(s)

Description—The hydrologic unit code (HUC) is a system for distinguishing and naming watersheds and subwatersheds (in multiple size classes) across the United States. Each hydrologic unit is identified by a unique hydrologic unit code consisting of 2 to 12 digits based on the 4 levels of classification in the hydrologic unit system. We recommend that the 6th-level (12-digit) HUC (the subwatershed level) be recorded for each GDE site. Multiple HUCs should be recorded if the site is in more than one 6th-level HUC.

Source—The HUC can be derived spatially if you have good location information (such as Universal Transverse Mercator [UTM] coordinates or latitude/longitude). The following USGS Web site describes and delineates HUCs: <http://water.usgs.gov/GIS/huc.html>.

Ecological Unit

Description—“Ecological units are areas of relatively stable environments that depict the inherent properties of their ecosystem elements” (Winthers et al. 2005, p. 51). Ecological units are divided into hierarchical levels that include section, subsection, landtype association (LTA), landtype (LT), or landtype phase (LTP).

Source—Section and subsection maps can be obtained from the ECOMAP 2007 Web site at http://svinetfc4.fs.fed.us/clearinghouse/other_resources/ecosubregions.html.

Alternatively, NRM-NRIS feature classes for these map units can be loaded from the Corporate Data Warehouse directly into an ArcMap project by following the directions at http://fsweb.nris.fs.fed.us/products/Inventory_Mapping/.

LTA, LT, or LTP feature classes can be used if available. If the administrative unit does not have LTs or LTPs, and the region does not have LTAs already in the NRM-NRIS database, then the default is to use the EcoMap Subsection. This can be derived spatially if you have good location information (such as UTM coordinates or latitude/longitude).

Ecological System

Description—NatureServe (2011) provides conservation status, taxonomy, distribution, and life history information for more than

70,000 plants, animals, and ecological communities and systems in the United States and Canada. Although GDEs are not explicitly identified in the database, a query of ecological systems using terms such as groundwater, seepage, fen, or spring will identify most of the GDEs in the inventory area. Examples of GDEs in NatureServe include Rocky Mountain Subalpine-Montane Fen and Piedmont Seepage Wetland. A list of GDEs from the NatureServe database is presented in appendix 5.

NatureServe has developed internationally standardized classifications for terrestrial ecosystems—mid-scale ecological units useful for standardized conservation assessments of habitat diversity and landscape conditions. Each system encompasses complexes of plant communities influenced by similar physical environments and dynamic ecological processes, including dependence on groundwater.

Source—The NatureServe Explorer Web site is available at <http://www.natureserve.org/getData/USecologyData.jsp>.

Local Feature-Type Name

Description—This local name is used to describe the type of feature being sampled. In some cases, this name can be found in the NatureServe list. Some common type names are cienega, fen, peatland, swamp, and wet meadow.

This local name can be helpful in understanding the type of site and the meaning of regional terms for springs and wetlands.

Mapping

This section describes maps and map sources necessary to locate and describe the site. A list of useful geologic map resources follows:

- Overview of USGS geology products and work—
<http://geology.usgs.gov/>.
<http://pubs.usgs.gov/of/2005/1305/>.
- Link to National Geologic Maps Database Web site for downloading by State, etc.—
http://ngmdb.usgs.gov/ngmdb/ngm_catalog.ora.html.

- Link to State geological surveys—
<http://www.stategeologists.org/>.

Metadata for State geologic data has been standardized over select Western States: Arizona, California, Idaho, Nevada, Oregon, Utah, and Washington.

For the Pacific Northwest, the major bedrock lithologic units can be obtained from a digital map on this USGS Web site:

<http://geo-nsdi.er.usgs.gov/metadata/open-file/95-680/metadata.faq.html>.

USGS Quad

Find the primary USGS topographic quad map where the site is located. The USGS system includes quadrangle boundaries for the United States available in the 1:250,000, 1:100,000, and 1:24,000 scales nationally. The USGS quad can be derived spatially once a Global Positioning System (GPS) location is established for the site.

Magnetic Declination

Record the bearing that should be used to adjust for local magnetic declination.

Geologic Map Name

Record the source for geologic mapping.

Geologic Map Unit

Determine the geologic unit at the site from the geologic map. This unit will be recorded in NRM-NRIS database. It is important for establishing the hydrogeologic setting. This can be derived spatially once a GPS location is established for the site and a digital geologic layer is obtained.

Land Resource Regions

The Land Resource Region and Major Land Resource Area of the NRCS can be obtained from the following Web site:

<http://soils.usda.gov/survey/geography/mlra/index.html>.

Soil Map Name and Unit

This is the soil map unit or the soils classification from the Terrestrial Ecological Unit Inventory (TEUI) map. This can be derived spatially once a GPS location is established for the site and a digital soil layer is obtained. It is useful to record the year the map was published and the taxonomic unit(s) of the map unit.

Route

Coordinates

Determine or estimate UTM coordinates or latitude/longitude before the site visit to help with the field crew arrival at the site. Update or confirm the coordinates during the field survey.

Location—Driving Route

Provide driving directions from the nearest town to the site (if the site is beside a road) or to a place where a vehicle is parked before walking to the site (e.g., a trailhead).

Location—Hiking Route

Provide hiking directions from a location where a vehicle is parked to the site. Give precise access directions beginning with a landmark (e.g., a named point on the topographic map, a major highway, marked trailhead) readily locatable on a 7.5-minute topographic map as the starting point. Use clear sentences that will be understandable to someone who is unfamiliar with the area and who has only your directions to follow. Give distances and use compass directions (true north, not magnetic north). When possible, provide a GPS path and the ArcMap project name where data are stored for use in Trimble or other GPS data logger. Avoid ambiguous words such as “above,” “near,” “beyond,” “on the back side of,” or “past.” If site locations lack major landmark features as guides, use township, range, and section information from topographic maps. Although the sample sites may not be permanently marked, others may want to relocate them for long-term monitoring purposes. Careful documentation of the access route and obvious landmarks are, therefore, important.

Location—Other

If appropriate, provide directions for other means of accessing the site, such as by boat or aircraft.

Other Information About the Site

Preliminary GDE Type

Before the site visit, what is the GDE type assumed to be? Select one or more from the following list:

- Spring/Wetland Type (modified from Springer and Stevens 2009)—
 - Cave—Groundwater emerges in or from a cave; common in karst terrain.
 - Exposure—Groundwater is exposed at the land surface but does not have surface inflow or outflow; occurs in karst (sinkholes) and lava flows but could form in other types of vertical conduits into an aquifer.
 - Fountain—Cool artesian spring that is forced above the land surface by stratigraphic head-driven pressure or carbon dioxide (CO₂).
 - Geyser—Intermittent geothermal spring that emerges explosively and usually erratically.
 - Gushet—Discrete source of flow pouring from cliff faces; typically emerges from perched, unconfined aquifers, often with dissolution enhancement along fractures; exhibits thin sheets of water flowing over rock faces.
 - Hanging garden or wet wall—Spring that emerges along geologic contacts or fractures and seeps, drips, or pours onto underlying walls; typically emerges from perched, unconfined aquifers in aeolian sandstone units.
 - Helocrene—Spring that emerges diffusely from low-gradient wetlands; often indistinct or multiple sources seeping from shallow, unconfined aquifers (may include fens and cienegas).

- Hillslope—Spring and/or wetland on a hillslope (generally 20- to 60-degree slope); often with indistinct or multiple sources of groundwater.
 - Hypocrene—A buried spring where groundwater levels come near, but do not reach, the surface in arid regions, typically due to very low discharge and high evaporation or transpiration. In humid regions, these features may be equivalent to shallow groundwater areas including wet meadows.
 - Limnocrene—Groundwater emerges in pool(s).
 - Mound—Spring that emerges from a mineralized mound, (usually carbonate) frequently at magmatic or fault systems. May also include springs issuing from peat mounds.
 - Rheocrene—Flowing spring that emerges directly into one or more stream channels. Spring-fed streams are also referred to as springbrooks or spring runs.
 - Other/unknown (describe in notes).
- Note which sources were used to make preliminary GDE type determination:
 - USGS map.
 - National Wetlands Inventory.
 - Forest maps.
 - Other map.
 - Previous forest inventories (vegetation or hydrologic).
 - TEUI/aquatic ecological unit inventory.
 - Photo.
 - Personal account.
 - Other:_____.

Archeological, Paleontological, Cultural, or Historic Sites or Use

Research records for cultural resources or historic use (e.g., archaeological or paleontological sites) at sites to be inventoried. This will help limit damage to important cultural resources.

Available Data

Seek out and list other sources of data that are available about the site.

Field Survey Activities

Appendix 6 lists equipment needed to implement this field guide. Field forms are in appendix 3. Metric units of measure are highly recommended to facilitate data summarization. Disturb the site as little as possible while collecting data, as described in appendix 4 (Site Protection Guidelines).

Survey Information

Survey Date

Record the calendar month, day, and year the site was visited. (This is a required field in Site General.)

Time

Record the time of day for the start and end of the field data collection.

Examiners

Record the first and last names of the crew that is doing the field data collection. (This is a required field in Site General.)

Weather

Weather can be important when interpreting water chemistry and water level information; for example, rain can alter the pH and conductivity measurements and raise the water table.

Record evidence of precipitation (rain or snowfall) during the sampling visit or evidence of recent rain or snowfall.

- Recent rain.
- Rain during survey.
- Snowfall, hail, or sleet during survey.
- Snow on ground.
- No current/recent precipitation.

Air Temperature

Record the daytime air temperature at the time of the visit.

Area of GDE

For very small sites, see box 2 before proceeding.

Description—This is a measure of the area or size of the GDE site. A GDE site generally has distinctive vegetation that is present because of the elevated water table. In some settings, such as drier regions, a very clear boundary may exist, which is evident from different vegetation or topographic differences, between the GDE and the uplands. In other settings, a more gradual transition from wetland to upland will occur, with significant zones of transition that include both wetland and upland plant species and very little change in slope. In such cases, the determination of the boundary of the wetland is somewhat subjective, and must be based, ultimately, on either a judgment call or detailed sampling. The following guides will help determine the extent of the GDE.

Hydrology—Water on the surface of the ground, or saturated ground (not from recent precipitation), can be an indication that the area is part of the GDE, although the absence of water does not preclude it from being part of the GDE.

Vegetation—The GDE will typically have obligate, facultative wet, and facultative wetland species, as distinguished by the Wetland Indicator Status of the U.S. Fish and Wildlife Service (1988). The edge of the GDE will generally be associated with a transition from those wetland species to more upland species. The presence of bryophytes could be indicative of a GDE wetland, although the absence of bryophytes does not indicate that it is not part of the GDE.

Landform—A change in slope (from flatter to steeper) can be associated with the edge of the GDE.

Peat or muck—The presence of peat or muck can indicate a GDE wetland. A boundary, with peat or muck on one side and no peat or muck on the other, could be an indication of the edge of the GDE. The absence of peat or muck does not preclude it from being within the GDE.

Spring—A spring will include an orifice, where water emerges, and possibly a pool and/or channel. Include the orifice and emergence zone, which generally includes obligate and facultative wetland plant species, as distinguished by the Wetland Indicator

Status of the U.S. Fish and Wildlife Service (1988), which are supported by the groundwater discharge or shallow water table. A key question in the application of this field guide is how much of an associated spring brook should be included in the site area. The response can be an arbitrary choice, based on a set run-out distance; a subjective decision, based on how far the riparian zone appears to be strongly influenced by the spring; or a more objective decision, such as one used in western arid regions, which considers the downstream boundary of the spring to be the point where the spring brook water temperature changes by 2 degrees Celsius. Pros and cons accompany each of these alternatives. In this field guide, 20 meters of the run-out stream, or spring brook, are included in the site area for sampling. If it is desirable to inventory (or monitor) a longer distance of a spring brook, then a stream and/or riparian protocol should be used to collect the data, which would then be considered as a separate (although companion) set of data from those collected from the spring as a part of this field guide.

How to measure and record—If possible, walk around the perimeter of the GDE when measuring or estimating size (to avoid excessive trampling). Determine the size of the GDE site (including all the spring and wetland features present) by one of the following methods (listed in order of highest to lowest recommendation):

1. GPS traverse of GDE edge. (Most GPS units have a feature that allows the operator to walk around the edge of the unit and determine the area.)
2. Measure the average width and length (for rectangular sites) or diameter (for round sites) using a tape (such as a 100-meter tape) or a rangefinder. Pacing with a known pace-length may also be done, although it is less accurate.
3. Estimate the size using topographic maps, orthophotos (GIS), satellite images (GIS or Google Earth), or aerial photos.
4. For larger features, where it might not be practical to walk the perimeter, it may be possible to sketch the perimeter in the GPS/data recorder (if using a unit that allows this type of GIS entry), using an image in the background. This measurement would require a GPS unit that uses software such as ArcPad, which allows the technician to sketch GIS features on the screen with aerial images as a background.

5. Estimate the area using the following classes (last resort):

- $< 2 \text{ m}^2$.
- 2 to 10 m^2 .
- 10 to 100 m^2 .
- 100 to $1,000 \text{ m}^2$.
- 0.1 to 0.5 ha.
- 0.5 to 1 ha.
- 1 to 10 ha.
- 10 to 100 ha.
- $> 100 \text{ ha}$.

Box 2

Note for Very Small Sites

Very small sites are vulnerable to damage from disturbance caused by the crew collecting data. Follow these guidelines for sampling very small sites (see appendix 4):

- Walk outside of the GDE site as much as possible.
- Record vegetation information from outside the GDE if possible.
- Take photos and draw the site sketch from outside the site.
- Consider skipping soil core and water table measurements.
- Do water measurements carefully.
- Make only one trip (or very few) in/across the GDE for measurements.

Reference Point

Description—A reference point is a spatial location or point on the ground that can be documented with GPS and plotted on a map. This point is valuable for plotting the site on a map and relocating a site for future sampling visits.

How to measure and record—For springs, the reference point should be the spring source (sometimes referred to as the spring

orifice). For wetlands that are relatively small, the reference point could be the center of the wetland or the wettest part of the wetland. For larger GDEs, the reference point could be the center of the site or some distinguishing feature within the GDE.

At the reference point, record the latitude and longitude coordinates (see Georeferencing section) that will enable someone to return to or near that location. Also record specific information or features that can be used to relocate the exact position of the reference point, ideally including a monumented tree, stake, fence, large boulder, or the distance and direction from some permanent feature such as a road or stream crossing.

Indicate where the reference point is on the site sketch (see Images section).

Slope

Description—The general incline of the site.

How to measure and record—Record the ratio of vertical rise to horizontal distance for the site expressed as percent. This is taken either at an average point on the site or as an average for a site.

Aspect

Description—The general direction that the landscape faces.

How to measure and record—Record the azimuth that the landscape faces at the center of the site or the majority of the site. Azimuth will be recorded from true north in degrees, 0 to 360.

Relative Area of GDE

Description—The percent of the area covered in general categories of GDE settings (complexes of springs, wetlands, open water, and other settings).

How to measure and record—Estimate the percent of the area within the GDE site that is covered by the following settings (must sum to 100 percent).

- Spring emergence.
- Channel (such as spring brook or other channel).

- Wetland/riparian.
- Open water (standing, not generally flowing).
- Other or unknown.

Georeferencing

Horizontal Datum

Description—This is the GPS datum used to record the location information in the field.

How to measure and record—Record the datum for the projection at the “reference point.”

- North American Datum of 1927 (NAD-27).
- North American Datum of 1983 (NAD-83) (recommended).**
- World Geodetic System of 1972 (WGS-72).
- World Geodetic System of 1984 (WGS-84).

GPS Equipment

Description—The make and model of the GPS equipment.

How to measure and record—Record the make and model of the GPS equipment used and the approximate GPS accuracy.

Universal Transverse Mercator Coordinates (from GPS)

UTM zone—This is the zone for the UTM projection. It can be obtained from quad maps or from GPS devices. UTM zone coordinates measure in meters east and north from two perpendicular reference baselines.

Easting—This is the distance in meters, east or west, from the central meridian of the UTM zone, which is designated at a value of 500,000 meters.

Northing—This is the distance in meters north from the equator from the UTM zone origin, which is designated as a value of zero meters. (This field guide addresses only north latitudes.)

Latitude and Longitude (from GPS)

Record the latitude and longitude at the reference point. This may be recorded either in degrees, minutes, and seconds, or in decimal degrees.

- **Latitude—degrees:**
(Range 0 to 90) The latitude degrees of the site as measured by GPS. (Default: north latitude.)
- **Minutes:**
(Range 0 to 59) The latitude minutes of the site as measured by GPS. (Default: north latitude.)
- **Seconds:**
(Range 0 to 59.99) The latitude seconds of the site as measured by GPS. (Default: north latitude.)
- **Longitude—degrees:**
(Range 0 to 180) The longitude degrees of the site as measured by GPS. (Default: west longitude.)
- **Minutes:**
(Range 0 to 59) The longitude minutes of the site as measured by GPS. (Default: west longitude.)
- **Seconds:**
(Range 0 to 59.99) The longitude seconds of the site as measured by GPS. (Default: west longitude.)
- **Latitude decimal degree:**
Latitude in a degree value. Consists of the latitude in degrees to at least 6 decimal places.
- **Longitude decimal degree:**
Longitude in a degree value. Consists of the longitude in degrees to at least 6 decimal places.

Elevation

Description—The elevation of the site.

How to measure and record—Record the elevation with a GPS unit at the reference point. Substantial error in GPS measurements may exist, but these data are adequate to characterize site elevation. For more accurate elevations, estimate them from a 10-meter Digital Elevation Model. Record to within ± 3 meters.

Note how elevation was determined.

- GPS unit.
- Topographic map (if necessary, interpolate between two contour intervals).
- Other:_____.

Geologic Setting

Evidence of Groundwater

Record the evidence that this ecosystem is groundwater supported. Use the decision tree in box 1 to help with this determination. Multiple answers are allowed.

- Flow from a spring source, contact, joint, or fault—indicating spring.
- Peat or muck accumulation significant.
- Standing water.
- Wetland vegetation.
- Other:_____.

GDE Type

Description—A general categorization of the GDE types at the site.

How to measure and record—Record the primary (dominant) GDE type and secondary GDE types present at the site. Only one primary type is recorded, but multiple secondary types can be recorded.

- Spring/Wetland Type (modified from Springer and Stevens 2009):
 - Cave—Groundwater emerges in or from a cave; common in karst terrain.
 - Exposure—Groundwater is exposed at the land surface but does not have surface inflow or outflow; occurs in karst (sinkholes) and lava flows but could form in other types of vertical conduits into an aquifer.

- Fountain—Cool artesian spring that is forced above the land surface by stratigraphic head-driven pressure or CO₂.
- Geyser—Intermittent geothermal spring that emerges explosively and usually erratically.
- Gushet—Discrete source of flow pouring from cliff faces; typically emerge from perched, unconfined aquifers, often with dissolution enhancement along fractures; exhibit thin sheets of water flowing over rock faces.
- Hanging garden or wet wall—Spring that emerges along geologic contacts or fractures and seeps, drips, or pours onto underlying walls; typically emerge from perched, unconfined aquifers in aeolian sandstone units.
- Helocrene—Spring that emerges diffusely from low-gradient wetlands; often indistinct or multiple sources seeping from shallow, unconfined aquifers (may include fens and cienegas).
- Hillslope—Spring and/or wetland on a hillslope (generally 20- to 60-degree slope); often with indistinct or multiple sources of groundwater.
- Hypocrene—A buried spring where groundwater levels come near, but do not reach, the surface in arid regions, typically due to very low discharge and high evaporation or transpiration. In humid regions these features may be equivalent to shallow groundwater areas including wet meadows.
- Limnocrene—Groundwater emerges in pool(s).
- Mound—Spring that emerges from a mineralized mound, (usually carbonate) frequently at magmatic or fault systems. May also include springs issuing from peat mounds.
- Rheocrene—Flowing spring that emerges directly into one or more stream channels. Spring-fed streams are also referred to as springbrooks or spring runs.
- Other/unknown (describe in notes).

Geologic Structure Type

Description—The geologic structure type is the kind of structure that may be controlling the flow of groundwater to the GDE, such as a geologic contact or fault plane. Many GDEs occur on geologic structures because they can create preferential pathways for the flow of groundwater. This is helpful for understanding the hydrogeologic setting of the site and from where groundwater is sourced.

How to measure and record—Record the type of geologic structure (preferential groundwater flow path) that is discharging water to the site. Observe the geologic units and geologic structure and compare that to a geologic map. Record your conclusions based on the following list:

- Bedding—Planar surfaces that visibly separate layers of stratified rock.
- Contact—Planar surfaces that separate different rock units.
- Fault—Fracture or a zone of fractures along which there has been displacement.
- Fracture—Fracturing in rock, without displacement.
- Lination—Any linear structure on the ground surface (in general, identified on aerial photography).
- Conduit—Tubular opening, common in karst terrain.
- Unknown.

Indicate source of conclusion:

- Observation.
- Geologic map.
- Other:_____.

Surficial Material

Description—This is the kind of unconsolidated material occurring at the surface. Many GDEs, particularly fens, develop on unconsolidated surficial materials. The type of material can influence the water chemistry and ecology.

How to measure and record—Record the kind of material occurring at the surface. Surficial materials are defined as nonlithified, unconsolidated sediments. They are materials produced by weathering, sediment deposition, biological accumulation, and human and volcanic activity. They include residual materials weathered from rock in situ; transported materials composed of mineral, rock, and organic fragments deposited by water, wind, ice, gravity, or any combination of these agents; accumulated materials of biological origin; materials moved and deposited by human actions; and unconsolidated pyroclastic sediments. Record the primary surficial material; secondary surficial materials may also be recorded.

- Alluvium—An unconsolidated accumulation of stream-deposited sediments, including sands, silts, clays, or gravels.
- Colluvium—Soil material and rock fragments moved downhill by creep, slide, slough, or local wash and deposited at the base of steep slopes.
- Eolian deposit—Wind-deposited sediments.
- Glacial deposit—Includes unsorted and unstratified till, including moraines, which are generally exposed in the uplands; and glacial meltwater deposits of sorted and stratified deltaic, stream, and lake sediments.
- Human-caused or constructed—Natural and manmade materials that have been artificially emplaced.
- Lacustrine sediments—Sediments deposited in lakes.
- Landslide deposit—Sediment deposited by downslope movement of a sorted or poorly sorted mass of soil or rock of mixed grain sizes, including rock falls, slumps, mud flows, debris flows, and earth flows.
- Marl—A friable deposit consisting of clay and calcium carbonate.
- Residuum—Weathered bedrock.
- Talus deposit—An accumulation of angular rock debris at the base of a cliff or steep slope that was produced by physical weathering.
- Volcanic unconsolidated material—Ash or mudflow.

- Rock—Bedrock with no surficial material present.
- Tufa or travertine deposits—Travertine is a sedimentary rock, formed by the precipitation of carbonate minerals from solution in ground and surface waters, or geothermally heated hot springs. Similar, but extremely porous, deposits formed from ambient temperature water are known as tufa.
- Other/unknown.

Lithology, Primary (groundwater source aquifer)

Description—Primary lithology describes the geologic materials such as bedrock or other surficial materials under a site. The groundwater source aquifer refers to the aquifer from which the groundwater is emanating. The primary lithology is generally the groundwater source aquifer. Primary lithology is useful for understanding the groundwater flow patterns. The location and hydrology of GDEs are controlled by the geology, and the type of rock can influence the water chemistry and ecology of the feature.

How to measure and record—If evidence in the field exists, then record one of the following primary lithology descriptors. If no evidence in the field exists, then answer this question in the office using the electronic resources listed in the “Mapping” section. If the groundwater emerges from a talus or other unconsolidated material at the base of a slope, then try to determine the upgradient geologic unit from which the groundwater is originating. The important bedrock lithology or geologic unit is the one supporting the aquifer that supplies water to the feature.

- Igneous extrusive.
- Igneous intrusive.
- Sedimentary.
- Metamorphic.
- Undifferentiated—Rocks for which finer age divisions are not specified on the map, small areas of rocks of different ages are too close together to be shown at the scale of the map, or the exact age relationships of the rocks in a given area may not yet have been determined.

- Unconsolidated—Loose sediment, lacking cohesion or cement.
- Unknown.
- Other:_____.

Indicate whether the primary lithology (noted previously) is also the groundwater source aquifer.

- Yes.
- No.
- Unknown.

Level of certainty for groundwater source aquifer—

- Known—Based on site investigation.
- Assumed—Based on professional opinion.
- Unknown—Needs further investigation.

Lithology, Secondary

Description—This is a finer scale description of the lithology of rock units occurring at the site and is tiered to the primary lithology of the aquifer from which the groundwater is emanating, or the original rock type that weathered to form the parent or surficial material.

How to measure and record—If evidence in the field exists, record the secondary lithology (tiered to the primary lithology) from the list in appendix 7, which is from Site General (USDA Forest Service 2009).

Landforms

Description—The location of many GDEs is related to the local geomorphologic history and existing landforms. GDEs may develop within, or adjacent to, certain types of landforms (e.g., at the toe of slumps and on stream terraces).

How to measure and record—Use a geologic map, air photo interpretation, satellite imagery, or field observations to select a “process/landform” from the list in appendix 8, which is from Haskins et al. (1998). Record the primary landform; secondary landforms may also be recorded.

Images

Photos

Description—Photos of the site are taken and stored electronically. Photos help to visualize the site, to compare one site to another, and to record change over time.

How to measure and record—A brief description of methods for photo point monitoring is presented here, while more detailed instructions can be found in the Forest Service, Pacific Northwest Research Station publication *Photo Point Monitoring Handbook* (Hall 2001). One photo can represent multiple points, as long as they are all noted.

Note: Photo points can be captured in a GPS and marked as such. The digital image can be stored with that point location and viewed by simply clicking on a point within a GIS project file.

Instructions for photos—

- Record the distance from camera to photo point (so that the same distance can be used in the future when the photo points are repeated)—
 - There are two ways to achieve this:
 - Always take photos a set distance from an object in the photo, such as a measuring staff (or folding 2-meter board).
 - or
 - For each photo, record the distance from the camera to an object in the photo, such as a measuring staff.
- Height of camera—
 - Always take the photo at a height of 1.5 meters above the ground.
- Light and time of day—
 - If possible, take photos in the middle of the day rather than early in the morning or late in the afternoon.
 - If possible, do not take photos looking into the sun.

- Photo identification board/card/sheet—
 - In each photo (top corner is recommended) include something (board, card, or sheet) with the following information written on it:
 - Site ID.
 - Photo number.
 - Date.
- Note the following on a photo form:
 - Info from photo identification card (Site ID, photo number, date).
 - What is in the photographed scene.
 - Distance from camera to object in photo.
 - Orientation of camera (compass bearing).
 - Time of day.
 - Weather.
- To improve comparability for rephotography, take photos as close as possible to the time and date of the previous photos.

Take photos for the following locations (some photos may serve more than one purpose, as long as each is noted):

- Reference point (defined previously).
- Center of site.
- Water measurement locations.
- Soil core locations.
- Spring source (if applicable).
- For springs with outflow channels—
 - Looking downstream, standing at/near source.
 - Looking upstream (or uphill), standing at/near source.
- Overview, from a hill (if possible).

Site Sketch Map

Description—This is a hand sketch of the site that includes sample locations, important features, etc. The sketch map is useful for understanding the site and to facilitate relocating the site on return visits. The sketch is also useful where GDE sites may be close to one another and map/GPS coordinates weakly describe the relative location of sample sites.

How to measure and record—Draw a sketch (hand-drawn map or electronic) of the site (see example in figure 4). One way to do this is to use an aerial photo to trace the boundary of the GDE onto a blank page that then becomes the sketch of the site. Graph paper is useful for drawing the sketch map, using the lines as known distances. The items in the following list should be captured and documented on the sketch map for each site.

- Reference point (described previously).
- Approximate locations/dimensions of major geomorphic surfaces.
- Springs—
 - Spring source.
 - Channel locations.
 - Structures including spring boxes, troughs, and pipelines.
 - Pool location, if limnocrene.
- Areas of standing water (indicate deepest part).
- Location of measurements—
 - Soil holes.
 - Water table measurement locations.
 - Wells/piezometers.
 - Water quality samples.
- Structures or other man-made features, such as roads, in or adjacent to GDE.
- Indication of north (true recommended, or magnetic).

- Indication of scale.
- Boundaries of GDE, or the delineation of the area sampled if only a portion of the site was sampled (the site was divided).

Figure 4.—Site sketch map example.

Forest Service GDE Level II Inventory

Site Name _____

Recorder _____

Page ____ of ____

Site Sketch Map

<p>To include on map:</p> <ul style="list-style-type: none"> <input type="checkbox"/> Reference point <input type="checkbox"/> Approximate locations/dimensions of major geomorphic surfaces <input type="checkbox"/> Springs: <ul style="list-style-type: none"> ○ Spring source ○ Channel locations ○ Structures including spring boxes, troughs, and pipelines ○ Pool location, if limnocrene <input type="checkbox"/> Areas of standing water (indicate deepest part) 	<ul style="list-style-type: none"> <input type="checkbox"/> Location of measurements: <ul style="list-style-type: none"> ○ Transects ○ Soil holes ○ Water table measurement locations ○ Wells/piezometers ○ Water quality samples <input type="checkbox"/> Structures or other man-made features <input type="checkbox"/> Indication of north (true recommended, or magnetic) <input type="checkbox"/> Indication of scale <input type="checkbox"/> Boundaries of GDE or area sampled
--	--

The sketch map shows an irregularly shaped area bounded by a thick black line labeled 'GDE BOUNDARY'. A dashed line represents a 'TRAIL' running from the top right towards the center. Six transects, labeled T1 through T6, are drawn across the site. Various measurement points are marked: 'R' for a reference point, 'S' for a spring source, 'Q' for water quality, 'A' for channel locations, 'B' for riparian areas, and 'C' for terraces. Solid black dots indicate soil and water table measurement locations. A north arrow points to the left. A scale bar at the bottom right shows 0, 2, and 4 meters. A legend at the bottom left defines the symbols used.

Unusual Sites

At sites on walls, such as gushets and hanging gardens, record whatever information can be observed from a safe distance. Other suggestions include—

- Take pictures.
- Use binoculars.
- Use a range finder.

Vegetation

Only very general information about vegetation is recorded in this Level I field guide. If quantitative data about vegetation is desired then the Level II field guide should be used.

Surrounding Vegetation

Description—This is a general description of the vegetation (generally upland) immediately surrounding the groundwater dependent ecosystem, as forested, shrubland, or herbaceous.

How to measure and record—Indicate the type of vegetation that is in the area immediately surrounding the GDE site using the following list of physiognomic orders from the National Vegetation Classification Standards (NVCS) as described in Brohman and Bryant (2005).

- **Tree dominated**—Areas where tree life form (see growth habit at NRCS PLANTS database at <http://plants.usda.gov/>) has at least 10 percent cover in the uppermost strata during the peak growing season.
- **Shrub dominated**—Areas where shrub and/or subshrub life forms are at least 10 percent cover in the uppermost strata.
- **Herbaceous/nonvascular dominated**—Areas where herbaceous and/or nonvascular life forms are at least 10 percent cover in the uppermost strata.
- **No dominant vegetation type**—Areas where vegetation cover is at least 1 percent, but the area does not classify as tree, shrub, or order herbaceous/nonvascular dominated.

- **Nonvegetated**—Nonvegetated order usually associated with open water or land-use-dominated, human-modified land, such as heavy industrial, commercial, and transportation facilities.

Dominant Life Form

Description—This is a ranking of the life forms with the greatest canopy cover in the GDE site. The cover for a life form is the total area covered by all species of that life form.

How to measure and record—Rank the dominant life forms of plants rooted in the GDE using the categories listed below. It is appropriate to rank two life forms with the same number if they have the same (approximate) amount of cover.

Rank (1 is greatest and 5 is least):

- _____ Tree.
- _____ Shrub and subshrub.
- _____ Graminoid.
- _____ Forb/herb.
- _____ Bryophyte.
- _____ Aquatic plants (submerged or floating).
- _____ Unknown.

Dominant Species

Description—This is a list of the dominant species within each life form. The dominant species within a life form is the species with the greatest canopy cover in that life form.

How to measure and record—Record the dominant plant species for each life form in the GDE. Record scientific names (such as *Picea engelmannii*) or symbols (such as PIEN) that are listed in the NRCS PLANTS database at <http://plants.usda.gov/>.

Species of Interest

Description—This is a list of species present at the site that are of interest for management, such as invasive species, rare species, or species that are specific to GDEs or a subset of GDEs such as a calciophyte, which is a plant that grows well in high-calcium settings. A regional list of invasive species would be helpful, as would a guide to identifying these species.

How to measure and record—List any species of interest (SOI) that are present at the site. In particular, look for invasive species, rare species, and species that are found primarily in GDEs or in a certain type of GDE.

Bryophytes

Description—This is a very general measure of the abundance of bryophytes (mosses, liverworts, and hornworts) at the site. Bryophytes can be important components of wetlands in terms of ecosystem functioning and as indicators of condition.

How to measure and record—Record the general abundance of bryophytes using the classes listed below:

- None.
- Minor component.
- Common component.
- Very abundant.

Plant Specimens

Description—Plant specimens are useful for identifying unknown species, confirming species identifications, providing vouchers, and helping with the training of future field technicians.

How to measure and record—If one of the dominant species is not known, then a specimen should be collected. Specific instructions for plant specimen collection are—

- Use the 1 in 20 rule as a guide: if fewer than 20 individuals are present at the site, do not collect the plant; instead, describe the plant, the setting, and take a photo.
- Collect as much of the plant as is reasonable, including—
 - Flowers or fruits.
 - Belowground parts, to show whether it has a caudex, tap root, rhizomes, etc. Clean dirt from the roots.
 - For woody plants, collect a portion of a branch with leaves and flowers/fruits/cones.
 - Two pieces (stems or branches).

- Complete a label (appendix 9) for each specimen with the following: plant (or unknown number), collection number, date, site name, project/unit, collector, answers to questions about the plant.
- Envelopes work well for small plants and seeds.
- Press the specimen in a plant press as soon as possible, with the label included.
- Air out specimens so they do not get moldy.
- List all collected specimens on a sheet or notebook.
- Make sure that any other data collectors at the site use the same unknown numbers for the same plants.

An experienced botanist should identify these specimens later, and that identification can be entered into the database in place of “unknown.”

Soil

Refer to the soils map to get an idea of the range of expected soils and whether the mapped soils are consistent with the soils observed at the site.

A single soil sample is taken to get a general idea of the amount of organic material and wetland soil features present. This sample is generally taken from the center of the site.

These soil sampling methods are generalized from USDA NRCS (2006) and Schoeneberger et al. (2002) and are intended to give a general characterization of the soils and focus mainly on the level and duration of saturation. Information on the soil profile gives an indication of the amount of peat development and peat texture, the degree of water table fluctuation, and some indication of the underlying aquifer materials. This field guide is not intended for soil mapping purposes or to generate rigorous characterizations of soil profiles for the entire wetland site. Methods here should not be used when regulatory or jurisdictional requirements must be met.

There are various ways to take soil samples, such as with a soil shovel (sharpshooter), an auger (to extract a core), or a soil push probe. A technique that minimizes disturbances is recommended.

If an auger is used, soil texture should influence the size of auger to be used. Water table elevations may also be recorded in the soil holes and these locations would also be logical locations for piezometers or minipiezometers should long-term water table monitoring be necessary (see Hydrology section). The depth of the soil sample should be about 50 centimeters to 1 meter, if possible. Advancement of the hole can stop when a total of 40 centimeters of organic soil is measured.

Wet soils and standing water are more difficult for soil sampling, but in many instances, it can be accomplished if the water is not too deep. Sampling soils at springs is not necessary if only a mineral substrate exists; however, if organic soil exists at a spring, then soil information should be recorded. The following list describes some reasons why soils information might not be collected:

- Small site, where sampling is considered too destructive.
- Threatened, endangered, or sensitive plant or animal species present at the site.
- Gravel, cobble, or boulder substrate.
- Deep water.
- Frozen ground.

An Equipment List for soil data collection is in appendix 6.

Location of Soil Sample

Description—This is the location within the site where soil information is collected.

How to measure and record—Record the location of the soil sample as one of the following:

- Center of site.
- Other: _____.
- Not taken because of (circle one): sensitive site, rocky substrate, deep water, or frozen ground.

Method of Extracting Soil

Description—This is the method or tool used to extract and observe soil. When analyzing soil information for the site, this will provide the level of reliability in the data collection effort.

How to measure and record—Record one of the following for each hole or core:

- Core/auger.
- Push probe.
- Shovel.
- Other:_____.

Depth of Peat or Muck

Description—Organic soils develop under saturated (water-logged) conditions that prevent decomposition. Histosols, histic epipedon, and the presence of fibric soil material (peat), hemic soil material (mucky peat), and sapric soil material (muck) are considered the maximum expression of anaerobiosis and are interpreted as indicators of extremely long-term saturation. Organic soil materials have organic carbon content (by weight) of 12 to 18 percent or more, depending on the clay content of the soil. Laboratory analysis of organic carbon content can be done if needed to respond to specific management questions.

How to measure and record—Record the depth where the peat, mucky peat, and muck layers begin and end in the first 80 centimeters. The definitions for the different organic layers to record are listed below:

1. Peat (fibric)—Undecomposed or weakly decomposed organic material; plant remains are distinct and identifiable; yields clear to weakly turbid water; no peat escapes between fingers.
2. Mucky peat (hemic)—Moderately to well-decomposed organic material; plant remains recognizable but may be rather indistinct and difficult to identify; yields strongly turbid to muddy water; amount of peat escaping between fingers ranges from none up to one-third; residue is pasty.
3. Muck (sapric)—Strongly to completely decomposed organic material; plant remains indistinct to unrecognizable; amounts

ranging from about one-half to all escape between fingers; any residue is almost entirely resistant remains, such as root fibers and wood.

Depth to the Mineral Layer

Description—This is a measure of the depth to the first dominantly mineral layer below any organic layer that may be present. If there exists a significant organic layer, such as peat, then the mineral layer would be below that. If there is a small or non-existent organic layer, then this depth will be shallow.

How to measure and record—Measure the depth from the surface to the first mineral layer (would be zero if no organic layer exists).

Texture of Mineral Layer

Description—Texture describes the mineral particle sizes and proportions in a sediment, such as clay, silt, and sand.

How to measure and record—Conduct a tactile evaluation of the soil texture of the first underlying mineral layer.

Color of Mineral Layer

Description—Color is useful to understand the composition of the soil and gives clues about the conditions the soil is subjected to.

How to measure and record—Describe the color of the first underlying mineral layer, using the Munsell color system chart.

Redoximorphic Features

Description—The type and location of redoximorphic features within the soil profile are used to interpret the degree of water saturation. Redoximorphic features, a result of iron (Fe) and manganese (Mn) oxidation and reduction, are not expected in organic soils, thus, there is no need to record redoximorphic features in histosols (40 centimeters or more of the upper 80 centimeters is organic soil); mineral soils having a histic epipedon (surface horizons of 20 centimeters or more thick of organic soil material and underlain by mineral soil material with a chroma of 2 or less); or mineral soils having peat, mucky peat, muck, or a mucky modified soil texture within 12 inches of the surface.

For all other soils, redoximorphic features can indicate the duration of saturation. Under long duration (many weeks to months) of water saturation and reduction, Fe oxide depletion features occupy the entire groundmass. The Fe oxide-depleted groundmass appears greyer or lighter in color. Short duration of water saturation or rapid fluctuation of water tables results in Fe/Mn oxide nodules and coatings.

How to measure and record—Record the presence and depth of the following features:

- Redoximorphic concentrations—Redox concentrations include soft masses, pore linings, nodules, and concretions (see glossary for definitions).
- Redoximorphic depletions—Bodies of low chroma (2 or less) having value of 4 or more where Fe/Mn oxides have been stripped or where both Fe/Mn oxides and clay have been stripped, see glossary for definitions. Soils having an abundance of gleyed material are saturated for long duration resulting in thorough reduction of iron to Fe⁺² (ferrous iron). It is the presence of ferrous iron that is responsible for the greenish colors of gley. An absence of iron concentrations within a gleyed zone indicates a stable reducing environment and that periodic, or seasonal, fluctuation of soil saturation does not occur at that depth.
- Reduced matrices—A soil matrix that has low chroma and high value, but in which the color changes in hue or chroma when the soil is exposed to air. The color change should occur within 30 minutes.
- Presence of bog iron—A large scale redoximorphic feature observed in areas where groundwater rich in reduced Fe moves to a more oxidizing environment.

Note: In soils derived from dark parent materials (value 4 or less, chroma 2 or less), redoximorphic features may be difficult if not impossible to recognize in the field.

Hydrogen Sulfide Odor

Description—A “rotten-egg smell” indicates that sulfate is being reduced, and therefore the soil is anaerobic. In most hydric soils, the hydrogen sulfidic odor occurs only when the soil is saturated and anaerobic.

How to measure and record—Record whether or not the odor is detected as the hole is dug and the soil is removed.

Reaction To Dilute HCL

Description—A carbonate reaction can help identify systems supported by calcareous aquifers. This is a measure that is useful for identifying rich fens.

How to measure and record—Acid is applied directly to the soil specimen. A positive reaction confirms the presence of carbonates. The carbonates may be primary, secondary, or both. Carbonates including dolomite in soil can be inherited from parent material and occur in the fraction less than 2 millimeters in size. The specimen can be placed in a spot plate and given time (1 to 2 minutes) to react. Dolomitic carbonates react slowly; the reaction can be easily overlooked. Carbonates may occur in specific locations, such as along faces of peds. A number of specimens and locations should be tested. Dolomitic carbonates or specimens with a low content of carbonates may be more easily recognized with acid concentrations greater than 1 meter.

Depth of Hole

Description—This is the maximum depth of the hole that was dug for soils data collection.

How to measure and record—Measure the depth of the pit or borehole from the surface to the bottom of the hole.

Fen Characteristics

Description—This is a search for areas with fen characteristics within the site. Fens are groundwater-influenced peatlands with high water tables. The consistently high water table creates anaerobic conditions that slow decomposition, which leads to the development of peat or muck, which is plant material in various stages of decomposition (Mitsch and Gosselink 2007).

For purposes of this field guide, we are first looking for areas with accumulations of peat or muck (supported by groundwater), which we call “fen characteristics,” and secondarily whether the soil meets the U.S. Fish and Wildlife Service’s (1999) definition of a fen.

In some areas of the United States, fens have special designation and protection (USFWS 1999), and the Forest Service may wish

to categorize wetlands as fen or nonfen wetlands. Common criteria and the U.S. Fish and Wildlife Service's (1999) definition used to classify a wetland as a fen are (1) the wetland is primarily supported by groundwater, and (2) the wetland has organic soils meeting the USDA NRCS (2010) definition of a histosol or a histic epipedon in at least some part of the contiguous wetland (see box 3). USDA NRCS (2010) also states the following: "It is a general rule that a soil is classified as an organic soil (histosol or histel) if more than one-half of the upper 80 centimeters (32 inches) of the soil is organic or if organic soil material of any thickness rests on rock or on fragmental material having interstices filled with organic materials."

How to measure and record—If a fen (groundwater-influenced peatland) was encountered during the systematic sampling, then record "yes" to the following fen characteristics question and use the soils data to determine if it meets the U.S. Fish and Wildlife Service's (1999) definition of a fen; no further searching is necessary.

If fen characteristics have not been observed during the site visit, then do a fen search by systematically walking through the site. The objective is not to find all fen areas at the site, but to determine if any fen areas exist at the site. While doing the search, pay particular attention to the wettest areas, where groundwater is at or near the surface for extended periods. Specific characteristics sometimes (but not always) associated with fens are—

- Wet or soggy conditions.
- Abundant mosses.
- Soft or spongy surface that bounces or shakes when walked on.
- Herbaceous vegetation of obligate wetland species (defined in the Glossary under "wetland indicator status").
 - A list of fen indicator species or "peat forming" species would be helpful, but they do not exist for all areas. One example of a fen indicator species list for California (Region 5) is in appendix B of Weixelman and Cooper (2009).
- Pattern of string and flark microtopography (hummock ridges and hollows).

If some of the previous characteristics are encountered in a particular area of a site, then evaluate the soil in that area as a target site (using methods described in this Soils section) to look for peat or muck. Record whether or not fen characteristics were observed.

Yes, fen characteristics were observed at the site, which include—

- Groundwater influenced.
- High water table.
- Peat or muck present.

No, fen characteristics were not observed at the site.

- In addition to the absence of the previous characteristics of fens, other clues indicating that it is probably not a fen include redoximorphic features or rock (cobble or larger) on ground surface. Areas influenced by beaver activity may appear like a fen, but may not actually be a fen.

Also answer whether the sites has soil that meets the USDA NRCS (2010) definitions of a histosol or histic epipedon:

- Yes, histosol or histic epipedon observed at the site.
- No, histosol or histic epipedon not observed at the site.

Box 3

Classifying Organic Soils

The “Keys to Soil Taxonomy” (USDA NRCS 2010) requires that **histosols** have organic soil materials that meet *one or more* of the following:

1. Overlie cindery, fragmental, or pumiceous materials and/or fill their interstices and directly below these materials have a densic, lithic, or paralithic contact.
2. When added with the underlying cindery, fragmental, or pumiceous materials, total 40 centimeters (cm) or more between the soil surface and a depth of 50 cm.
3. Constitute two-thirds or more of the total thickness of the soil to a densic, lithic, or paralithic contact and have no mineral horizons or have mineral horizons with a total thickness of 10 cm or less.

Box 3 (continued)

4. Are saturated with water for 30 days or more per year in normal years (or are artificially drained), have an upper boundary within 40 cm of the soil surface, and have a total thickness of *either*—
 - a. 60 cm or more if three-fourths or more of their volume consists of moss fibers or if their bulk density, moist, is less than 0.1 g/cm³.
 - b. 40 cm or more if they consist either of sapric or hemic materials, or of fibric materials with less than three-fourths (by volume) moss fibers and a bulk density, moist, of 0.1 g/cm³ or more.
5. Are 80 percent or more, by volume, from the soil surface to a depth of 50 cm or to a glacic layer or a densic, lithic, or paralithic contact, whichever is shallowest.

The “Keys to Soil Taxonomy” (USDA NRCS 2010) defines a **histic epipedon** as a layer (one or more horizons) that is characterized by saturation (for 30 days or more, cumulative) and reduction for some time during normal years (or is artificially drained) and *either*:

1. Consists of organic soil material that—
 - a. Is 20 to 60 cm thick and either contains 75 percent or more (by volume) *Sphagnum* fibers or has a bulk density, moist, of less than 0.1.
 - b. Is 20 to 40 cm thick.
2. Is an Ap horizon that, when mixed to a depth of 25 cm, has an organic-carbon content (by weight) of—
 - a. 16 percent or more if the mineral fraction contains 60 percent or more clay.
 - b. 8 percent or more if the mineral fraction contains no clay.
 - c. 8 + (clay percentage divided by 7.5) percent or more if the mineral fraction contains less than 60 percent clay.

Most histic epipedons consist of organic soil material. Item 2 provides for a histic epipedon that is an Ap horizon consisting of mineral soil material. A histic epipedon consisting of mineral soil material can also be part of a mollic or umbric epipedon.

Hydrology

An Equipment List for hydrologic data collection is in appendix 6.

Water Table

In general, water table measurements will be done at wetlands and not at springs, although exceptions do occur. Water table data will be collected at one point, which may be in the boreholes created during soil sampling, or other locations.

Note: One-time water table measurements give only a general idea of the water table for a site. Multiple measurements during the season using piezometers would provide information about the variability (or seasonality) of the water table. Methods to collect more detailed groundwater data are described in separate technical notes, which can be found on the Minerals and Geology page on the Forest Service Web site: <http://www.fs.fed.us/geology>.

- *Groundwater Monitoring Well Installation in Wetlands.*
- *Groundwater Level Measurements.*
- *Analysis of Groundwater Level Data.*

Location of Water Table Measurements

Description—The location within a wetland where a water table depth measurement is taken will be at either an unbiased or targeted location. In general, wells or piezometers are required for meaningful, long-term water table monitoring.

How to measure and record—Establish locations using one of these methods:

- Randomly chosen point (unbiased).
- Center of site (unbiased).
- Other (targeted):_____.

Source of Water Table Measurements

Description—This indicates the source of the water table depth measurement or where it was taken in a wetland. This helps with interpreting the water table data.

How to measure and record—If wells are installed, the water table measurements should be taken from the wells rather than from the soil core boreholes. Note which of the following sources was used:

- Soil core borehole.
- Depression.
- Well/piezometer.
- Other:_____.

Hole Depth

Description—This is the maximum depth of the hole where the water table data are collected. If the soil hole is used, then this will be the same value entered for the soil hole depth.

How to measure and record—Measure the depth of the pit or borehole from the surface to the bottom of the hole.

Water Table Depth

Description—This attribute helps to establish the depth to water below the ground surface in wetlands. It would probably not be measured at springs that do not have an associated wetland, because the water table or piezometric surface at a spring is by definition at the surface.

This attribute helps provide an understanding of conditions that influence plant species, particularly wetland plant species that are highly dependent on a shallow water table for survival. Small changes in water table depth can cause changes in wetland plant community composition.

How to measure and record—Groundwater depth (centimeter) is measured in the borehole from the soil core or by augering a hole. The appropriate depth of a hole is somewhat site specific, but would typically be a 0.5 to 1 meter or to the bottom of the peat (where applicable). Be aware that once the hole penetrates below the bottom of a peat layer, the water level may rise in the borehole, indicating artesian conditions. Peat layers are occasionally confining units and can sometimes “float” on the underlying aquifer. Therefore, in those situations, the water level measured in a hole would represent the piezometric surface of the hydrogeologic unit underlying the peat, which frequently

exhibit strong upward vertical hydraulic gradients. To get the true water table elevation within the peat, the borehole must not penetrate through the base of the peat.

Before measuring water table depth, allow time for water in holes to equilibrate (at least 30 minutes, but preferably a few hours). Water table measurement could be taken just prior to refilling the boreholes at the end of the field day, which would provide time for the water in the hole to equilibrate with the water table.

If water is at or above the surface, then it is not necessary to auger a hole or measure water table depth. The water table would be at the surface or at a depth of zero.

Steps to measure water table depth:

- Auger a hole approximately 0.5 to 1 meter in depth. A hole can also be dug using a sharpshooter shovel although this creates more disturbance to the wetland.
- Allow the water level in the hole to equilibrate. Monitor the water level depth to determine when the water level has stabilized.
- Lay a shovel or similar object across the top of the soil pit opening and measure from the bottom of this object. Record the distance to water.
- For standing water, record zero, which indicates the water is at or above the ground surface.

If no water remains in the hole, even after waiting for a period of time, then record it as “dry.”

Water Table Type

Description—This describes the type of water table that exists at the site based on observations made while measuring the water table depth. This information gives insight into the vertical gradients in the underlying aquifer.

How to measure and record—Choose the term that best describes this site, based on the water table measurements taken previously.

- **Apparent**—Water level stabilized in a fresh unlined borehole.
- **Artesian**—The static level within a cased borehole where water rises above an impermeable layer (e.g., peat layer)

due to a positive hydrostatic head or where water discharges from an unlined borehole.

- Ponding—Standing water on top of the soil.
- Unknown.
- Other:_____.

Flow

Flow Patterns for Site

Description—This indicates whether the inflow and outflow are surface water, groundwater, or a combination of the two. This helps to characterize the overall water budget of the wetland. The water budget of wetlands varies in the dependence on groundwater inflow/outflow or surface water inflow/outflow.

How to measure and record—

Inflow (select one):

- Dominated by groundwater inflow.
- Dominated by surface water inflow and/or precipitation.
- Substantial amounts of both groundwater and surface water inflow.

Outflow (select one):

- Dominated by groundwater outflow.
- Dominated by surface water outflow.
- Substantial amounts of both groundwater and surface water outflow.
- Dominated by evapotranspiration.

Occurrence of Surface Water

Describe the occurrence of surface water at the site using one of the following categories (may select multiple):

- No standing or flowing water visible.
- Patches of standing water.
- Extensive standing water.
- Flowing water in channels.

Flow Instrument

Record the name of the instrument used to measure flow (or discharge). The instrument will vary depending on the site type; therefore, multiple options are presented in appendix 10.

Flow Method

Record the method used to measure flow (or discharge). The method will vary depending on the site type; therefore, multiple options are presented in appendix 10.

Flow Rate

Description—This is a measure of the discharge from the aquifer to the surface. This attribute is more important for springs than wetlands supplied by diffuse discharge. The flow of a spring is important for both ecological reasons and human uses of the spring water. In many cases, the flow of a spring correlates with the ecological functions and values of the spring habitat.

Where to measure flow—If measuring a single channel, measure discharge as close as possible to the spring source. In some situations, there will not be a single distinct channel where flow can be measured, in which case follow these guidelines:

- If there are multiple channels, and if they all converge to a single channel, measure discharge in the single channel as close as possible to the confluence of all of the multiple channels.
- If there are multiple channels that do not converge, then measure flow in as many channels as possible. Record each measure with an explanation that it is different (completely or partially) than other measures of flow at the site.
- For hanging gardens and wet walls, if possible, take a flow measurement at the base of the wall where flow coalesces into a channel. If this is not possible, photo documentation of the wetted area of rock face is an option.
- If flow is very diffuse (as in a sloped wetland or seep), then flow measurements may not be possible.

How to measure and record—Flow measurement applies mainly to springs, but can be applied to wetlands that have flowing water, such as in an inflow, an outflow, or distinct channels.

Measure the quantity of water discharging from the GDE with one of the methods listed in appendix 10, which also describes the measurement methods. Flow should be measured and recorded multiple times (three times is recommended) at the same location to increase accuracy. Multiple measures at different locations might also be necessary to capture the totality of flow. Record and store all flow measurements (in the field and in the database) to allow for accurate analysis of flow for the site.

Also record an estimate of the percent of the surface discharge that was captured.

For limnocrenes that do not have outflow, the static head change method is used. For limnocrenes that have an outflow, use one of the other measurement techniques described previously.

If flow was not measured, then explain why by selecting one of these options:

- Diffuse outflow.
- No outflow.
- Not a spring.
- Spring is dry.
- Other:_____.

Note: It may be difficult to estimate the discharge of springs and wetlands that (1) are small, (2) have water that is shallow and broadly or unevenly spread over a wide area, or (3) have limited moving water. Discharge often changes throughout the day (because of evapotranspiration), seasonally, or annually, which decreases the effectiveness of single measurements to precisely quantify long-term discharge characteristics. Highly quantitative discharge measurement would be a component of a Level III survey.

Record notes on flow—Make notes on evidence of recent high discharges, such as high water marks, oriented vegetation, or debris on or above the channel or floodplain.

Spring Channel Characteristics

For sites that have spring brooks or outflow channels, record information for the following questions.

Hydroperiod

Description—This describes the temporal flow characteristics of a spring. This information is valuable for assessing the importance of the spring for habitat for aquatic organisms. Perennial springs are frequently of higher value for aquatic and terrestrial species than are ephemeral springs.

How to measure and record—Estimate the hydroperiod of the spring. If the field visit takes place in the dry season and the spring is flowing, it is likely perennial.

- Perennial (must have continuous flow at time of visit).
- Intermittent (visible evidence of flow, known to flow at certain times of the year).
- Not determined.

Length of Outflow Stream

Description—This is an estimate of the length of the spring brook up to a maximum of 20 meters down gradient. Twenty meters is an arbitrary cut-off that has been established because at some distance downstream, the spring brook changes from a spring-specific habitat to a lotic habitat because of cumulative changes in flow, temperature, and water quality. The spring brook serves as a habitat for many spring-specific species (crenobiontic species), so its length is of interest for understanding aquatic biology.

How to measure and record—Record the distance of the spring brook to the downstream limit of surface flow from (1) the source (orifice) of a spring (that does not have a wetland between the spring and the outflow channel), (2) the point where water coalesces into a channel for diffuse springs and discharge wetlands, (3) the outflow from a limnocrone, or (4) the downgradient edge of a wetland.

- < 5 meters
- 5 to 10 meters
- 10 to 15 meters
- 15 to 20 meters
- > 20 meters

What Happens to Stream Outflow

Description—This is a general description of what happens to the spring brook or stream downstream of the sampling area.

How to measure and record—If flow continues beyond 20 meters (downstream of the site), then also note what happens to the flow after the 20 meters using the following options:

- Disappears into the ground.
- Continues as far as can be seen.
- Flows into another stream.
- Some flow is diverted.
- Becomes intermittent.
- Other: _____.

Water Quality

Some core field-derived water quality parameters are included to help characterize the site. These are the following: temperature, specific conductance, pH, and either oxidation/reduction potential (ORP) or dissolved oxygen (DO). In addition, water samples may be collected for laboratory analysis of a wider range of water quality parameters, if they are needed to address the management requirements for the field guide implementation.

Detailed instructions for collecting water samples from wells and surface waters and analyzing those samples, along with quality assurance/quality control procedures can be found in the USGS National Field Manual for the Collection of Water-Quality Data (National Field Manual). The National Field Manual provides guidelines and standard procedures for USGS and other Government agency personnel who collect samples used to assess the quality of the Nation's surface-water and groundwater resources. Each chapter of the National Field Manual is published separately and revised periodically. Newly published and revised chapters are posted on the USGS Web page "National Field Manual for the Collection of Water-Quality Data," <http://water.usgs.gov/owq/FieldManual/>.

If there are wells, the water quality samples should be taken from the wells with a bailer or pump. For springs or discharge areas within wetlands, water quality measurements should always

be taken at the source. Water in wetlands may be ponded or flowing. In either case, targeted samples should be collected from an area that has sufficient depth, is within the wetland, and away from inlets (natural or anthropogenic) because inlets may influence the composition of the water sample. In summary, water quality sampling should be done at one of the following locations, which are listed in order of preference:

- Wells in wetlands (if present) and at the source (orifice) of springs.
- Where flowing water exists in wetlands.
- Standing surface water.
- Holes created by the soil sampling.
 - Time is needed for water to equilibrate.
 - Temperature may be the only attribute that can be accurately measured in a borehole because the other water quality attributes (conductivity, pH, DO and/or ORP) may be affected by the digging process.

Location of Water Quality Measurements

Description—The location within a wetland or spring where a water sample or measurement is collected.

How to measure and record—Surface water quality sampling should be completed before collecting data for other indicators to avoid degrading the water while completing other sampling tasks. Use flagging if necessary to keep crew members clear of the water sampling location until the water has been sampled. The location of the water quality measurement is either an unbiased location or a targeted location.

- Unbiased—
 - Randomly chosen point.
 - Center of site.
- Targeted location—
 - Spring source (recommended for springs).
 - Down gradient from spring source.
 - Stream exiting wetland.

- Standing water (includes pools).
- Hole (dug or augered; including soil sample hole).
- Well/piezometer.
- Other:_____.

Time of Water Quality Measurements

Description—This is the time of day that the sample or measurement was collected. This information will help with the interpretation of the data because many water quality parameters fluctuate diurnally because of temperature changes, evapotranspiration, and photosynthesis.

How to measure and record—Record the time of day that the sample or measurement was taken.

Temperature of Water

Description—This is the temperature of the groundwater discharging at the spring or wetland. Water temperature is an important factor structuring aquatic communities, and it may give insight into the source of the groundwater. The temperature of water discharging from a spring is particularly meaningful. The temperature of water discharging to the surface of a wetland is not an accurate measure of groundwater temperature, but it provides general evidence about the temperature of the groundwater. Extreme temperature values might be an indication that more careful work is needed.

How to measure and record—One way to measure water temperature is with an electronic device that also measures dissolved oxygen or conductivity. Calibration is not necessary for temperature measurements using a high-quality device. Record in degrees Celsius. Expected ranges of values are 4 to 60 degrees Celsius. For springs unaffected by geothermal heating, the water temperature is generally close to the average annual temperature of the recharge area.

Water pH

Description—pH is the measure of hydrogen ion activity, which indicates the acidity or alkalinity of water. It is measured on a scale from 0 to 14, with a pH of 7 indicating neutral conditions. Smaller numbers indicate acidic conditions; larger numbers

indicate basic conditions. The pH typically responds to hydrologic disturbance in wetlands; therefore, pH can be an indicator of disturbance. The pH is also important in classifying wetland sites (Cowardin et al. 1979), and defining rich and poor fens. Aquatic fauna and flora are also sensitive to pH conditions. The pH of rain is about 5.6, but can range from 5.6 to about 4.5.

How to measure and record—Measure the pH of the water using a hand-held field meter. The meter should be kept clean, with fresh batteries, and calibrated at least daily, following the manufacture's recommendation. pH probes generally have a limited lifetime, and a backup probe should always be carried. A backup meter is highly recommended. Record in standard pH units. The expected range of pH values is 4.0 to 8.0.

Specific Conductance of Water

Description—Specific conductance (also called electrical conductance, or conductivity) is the measure of the ability of an aqueous solution to carry an electrical current. This ability is dependent on the amount of dissolved ions in the solution, and is, therefore, an indicator of total dissolved solids in the solution. Conductivity provides insight into water sources and it is an indicator of conditions important to aquatic life because of requirements to maintain osmoregulatory balance. Conductivity typically responds to hydrologic disturbance in wetlands. Conductance is also important in classification of wetland sites (Cowardin et al. 1979).

How to measure—Measure conductivity using a field meter. The meter should be kept clean, with fresh batteries, and calibrated periodically following the manufacture's recommendation. Most high-quality meters do not require frequent calibration. Record in microsiemens/centimeter ($\mu\text{S}/\text{cm}$). Expected ranges of values are 10 to 5,000 $\mu\text{S}/\text{cm}$.

Oxidation-Reduction Potential or ORP (DO is an Alternative)

Description—Oxidation-reduction (redox) reactions (reactions involving electron transfer) mediate the behavior of both inorganic and organic chemical constituents by affecting solubility, reactivity, and bioavailability. This data will help provide information about the biogeochemistry of wetlands, which is controlled largely by oxidation-reduction reactions. Expected values for redox potential (also called Eh) range from -300 millivolts (mV) to

+700 mV (see figure 5). Redox potential is significantly affected by the oxygen content of the soil and porewater. In oxidized systems where aerobic organisms function, the Eh range is very narrow, approximately +700 mV to about +300 mV. Below values of +300 mV, facultative anaerobes (primarily bacteria) function down to about 0 mV. Below this range, obligate anaerobes function. In wetland (waterlogged or flooded) soils, Eh can be anywhere along the entire scale. Where oxygen is present in wetland soil, the Eh can be as high as in a drained soil, but where oxygen is not present, Eh can be very low (-250 to -300 mV) (U.S. EPA 2008). The Eh-pH diagram in figure 6 can be used to interpret the ORP measurements.

Figure 5.—Range of ORP values for wetlands.

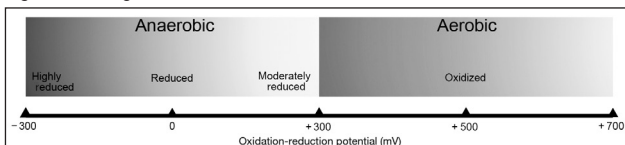
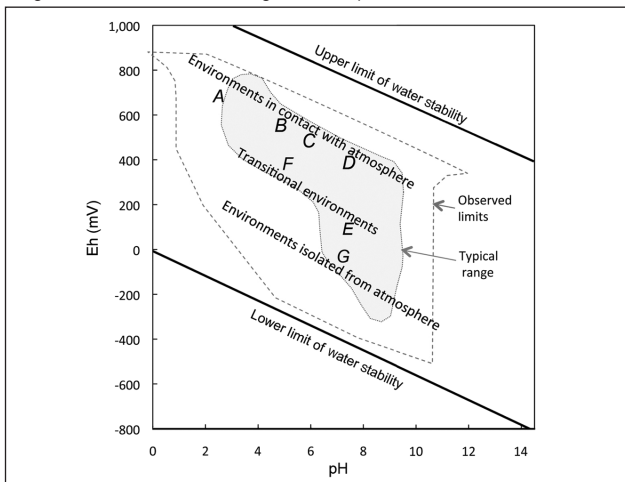

Figure 6.—Distribution of Eh-pH values in natural aqueous environments. Zone A is acidic mine drainage, B is rain, C is stream water, D is ocean water, E is groundwater, F is bog water, G is anaerobic wetlands (redrawn from Langmuir 1996 and Baas-Becking et al. 1960).



Note: Measured ORP values have to be converted to Eh to be able to use the Eh-pH diagram in figure 6. Converting ORP measurements to Eh depends on the type of ORP electrode used. The electrode manufacturer typically provides conversion factors for various temperatures.

How to measure and record—Measure the ORP of the water using a hand-held field meter that has been calibrated using Zobell solution. ORP in water is measured in wells, springs, and standing or flowing water. The meter should be kept clean, with fresh batteries, and calibrated daily following the manufacturer's recommendation. Record in mV.

Dissolved Oxygen or DO (alternative to ORP)

Description—This is a measure of the amount of DO in the groundwater discharging at a spring or wetland. DO at a spring gives insight into the source of the groundwater discharging and the residence time in the aquifer. In a wetland, DO is a function of the biogeochemical processes taking place.

Because fish and other aquatic organisms cannot survive without oxygen, DO is an important water quality parameter for surface water systems. Cold water holds more oxygen than warm water. Pure water at 4 degrees Celsius (40 degrees Fahrenheit) can hold about 13.2 milligrams per liter (mg/L) DO at 100 percent saturation, while pure water at 25 degrees Celsius (77 degrees Fahrenheit) can hold only 8.4 mg/L at 100 percent saturation. Water with a high concentration of dissolved minerals cannot hold as much DO as pure water.

How to measure and record—Measure DO using a field meter. The meter should be kept clean, with fresh batteries, and calibrated at least daily following the manufacture's recommendation. If there are weather fronts moving through the area, it may be necessary to calibrate before each measurement. Record DO in mg/L. Expected ranges of values for DO are 0 to 13 mg/L.

Aquatic and Terrestrial Fauna

Description—Springs and wetlands can provide important habitat for aquatic and terrestrial fauna, which can be important for management and restoration. Aquatic macroinvertebrates, in particular, are useful bioindicators because some taxa are sensitive to disturbance while others are tolerant.

How to measure and record—Record the important taxonomic groups of animals observed at the site. Important taxonomic groups that occur in GDEs are those with species that have the greatest implication for management. These can include threatened and endangered species, sensitive species, spring-specific species (spring snails), fish, amphibians, reptiles, invertebrates, and mammals. A substantial amount of training is needed to identify many of these species, but identifying most groups of animals, and many nonnative species, may be accomplished with minimal training. Appendix 11 (Identification of Freshwater Invertebrates) provides representative drawings of groups of aquatic macroinvertebrates that may be found in springs and other GDEs and a “Key to Macroinvertebrate Life in the River.” For Level I surveys, the presence or absence of important species or groups is an important goal.

Voshell (2002) is a useful publication for identifying freshwater invertebrates that can be used by a minimally trained person for a Level I survey. In addition, many State agencies and universities host Web sites with macroinvertebrate identification keys.

Species of Interest

List any known invasive species that are present. Invasive species could include zebra mussel, red-rimmed melania, or New Zealand mud snail. See USGS’ Nonindigenous Aquatic Species (<http://nas.er.usgs.gov/>) for lists and information on invasive freshwater mollusks and crustaceans.

List any rare or sensitive species that are present.

List any GDE-specific species that are present and explain interest.

Natural and Anthropogenic Disturbance

Record any disturbances observed at the site. This can provide managers with information on activities or structures that may be detrimentally affecting the structure and function of the site. It can be helpful to make notes about disturbances observed.

Hydrologic Alteration

Description—This is a list of activities or structures that have altered the natural hydrologic function of the system. This can

provide managers with information on activities or structures that may be having a detrimental effect on the hydrologic function of the feature. Multiple answers are allowed.

How to measure and record—

- Water diversion—Water permanently diverted away from spring habitat (ditch, pipeline, spring box, or other form of dewatering).
- Water diversion—Water eventually returns to spring habitat.
- Upgradient extraction of surface water or groundwater (prespring emergence).
- Downgradient capture of surface water or groundwater (post-spring emergence).
- Extraction of water within a wetland.
- Extraction of water at spring source.
- Regulated water flow by impoundment/dam.
- Pollution.
- Flooding.
- Wells.
- Other: _____.
- None observed.

Volume and Percent Diverted

Record the volume and percentage (to nearest 10 percent) of water being diverted (noted previously) at the time of inspection. Indicate whether this was a visual estimate or a measurement (e.g., flow meter). Inspect flow upstream and downstream of diversion, as well as water in the conveyance, if possible, to determine percentage being diverted.

Soil Alteration

Description—This is a list of the major types of soil alteration found at the site. Multiple answers are allowed.

How to measure and record—

- Channel erosion.
- Compaction.
- Debris flow.
- Deposition.
- Displacement of soil.
- Erosion (general).
- Evaporate deposition.
- Excavation.
- Ground disturbance (general).
- Gully erosion.
- Mass wasting.
- Mining.
- Pedestals or hummocks (created by people or animals).
- Pedestals (small-scale, rain-splash induced).
- Pipes.
- Rill erosion.
- Ruts (from vehicle tread).
- Sheet erosion.
- Slump.
- Splash erosion/soil crust.
- Wind erosion.
- Soil mixing/churning.
- Soil removal (peat mining).
- Trails (by people or animals).
- None observed.
- Other:_____.

Structures

Description—This is a list of the kinds of structures present at the site. Multiple answers are allowed.

How to measure and record—

- Buried utility corridors.
- Enclosure (such as spring house, spring box, or concrete enclosure).
- Erosion control structure.
- Enclosure fence.
- Oil and gas well.
- Pipeline.
- Point source pollution.
- Power lines.
- Road (includes construction and maintenance).
- None observed.
- Other: _____.

Recreation Effects

Description—This is a list of recreational activities in evidence at the site. Multiple answers are allowed.

How to measure and record—

- Camp sites.
- Tracks or trails by vehicles (all-terrain vehicle [ATV], 4-wheel drive, etc.).
- None observed.
- Other: _____.

Animal Effects

Description—This is a list of animal-related impacts to the site. This includes impacts from both domestic and wild animals. Multiple answers are allowed.

How to measure and record—

- Beaver activity.
- Feral animals.
- Grazing or browsing (by ungulates).
 - Wild animals.
 - Livestock.
- Trails by animals and people.
- Trampling (by ungulates, native or nonnative).
- None observed.
- Other: _____.

Miscellaneous

Description—These are potential disturbances that do not fit in the categories described previously. Multiple answers are allowed.

How to measure and record—

- Fire.
- Tree cutting (timber harvest or other).
- Refuse disposal.
- None observed.
- Other.

Archeological, Paleontological, Cultural, or Historic Sites or Use

Description—This is a list of any archeological, paleontological, cultural, or historic sites or other human use of the site. Many

springs in arid regions have a long history of use by Native Americans and others. Some have spiritual values associated with them. Some fens have preserved remains of extinct animals. Knowledge of sensitive sites will limit inadvertent damage to these resources.

How to measure and record—Record evidence of archeological, paleontological, and cultural resources or historic use (e.g., archaeological, paleontological, historic sites).

Management Indicator Tool

Responses to the Management Indicator Tool statements are used to identify potential need for management action based upon observations and information collected during the field guide implementation. This information may be useful for prioritizing sites needing additional monitoring or other management actions. The tool should be completed at the site, using a field crew consensus approach, and conclusions validated or confirmed later in the office based on a review of the data collected and other records or information available at the office (e.g., land status records, land and resource management plans). Some of the statements, particularly “Administrative Context,” may require review of records before the field visit.

This tool uses “true” or “false” answers, which by definition require interpretation by the field team and have undefined cutoffs. Make the best judgment possible and include comments and explanations where uncertainty or mitigating factors entered into the assessment. In particular, provide comments for all responses of False (No), Does not apply, or Unable to assess.

False answers indicate issues of concern that might pose problems for the long-term functioning of the GDE or when observed at multiple sites indicate a need for management attention. There is no summary scoring system based on the results of this tool. It is up to the specialist involved in data collection and the decisionmaker responsible for management to interpret the inventory results.

The following other resources were used for assessing management needs and to develop portions of the Management Indicator Tool.

Assessing proper functioning condition for fen areas in the Sierra Nevada and Southern Cascade ranges in California: a user guide (Weixelman and Cooper 2009).

A user guide to assessing proper functioning condition and the supporting science for lentic areas (Prichard 2003).

Springs ecosystem assessment protocol scoring criteria (Stevens and Springer in development).

Following are the 25 management indicator statements to address.

Aquifer functionality: No evidence suggests that the aquifer supplying groundwater to the site is being affected by groundwater withdrawal or loss of recharge.

GDEs exist where groundwater reaches the earth's surface, often through complex and lengthy geologic flow paths. The consistent supply of groundwater maintains flows in springs and high water tables in wetlands. This supply of groundwater is essential to maintain the GDE and, in many cases, unique plant and animal communities. This statement asks whether activities exist that interrupt or deplete this supply—reducing flows in springs or lowering water tables in wetlands.

Examples

This indicator would be answered “Yes” in the following circumstances:

- No evidence suggests that groundwater extraction is adversely affecting the site.
- Evidence of soil saturation exists, or standing water is apparent.
- Plants that are obligate wetland and/or facultative wetland species are abundant at the site, taking into consideration the setting and site potential.
- None of the adverse effects in the following list are observed.

This indicator would be answered “No” in the following circumstances:

- Groundwater extraction, such as pumping wells or mining that intersects the water table, damages aquifer functionality.

- There is depletion of recharge to the aquifer through paving, soil compaction, vegetation manipulation, etc.
- Soil saturation in a wetland, or flow of a spring, is less than in the past. One indicator of this could be where upland and facultative upland plant species are encroaching into areas formerly dominated by obligate wetland and facultative wetland species, indicating a loss of groundwater. Another indicator could be if hydric soils are present beyond the current extent of the GDE, suggesting that the GDE has decreased in size.

The only definitive way to detect aquifer functionality issues is through installation and monitoring of piezometers in wetlands and frequent monitoring of flow in springs.

Watershed functionality: Within the watershed, no evidence suggests upstream/upgradient hydrologic alteration that could adversely affect the GDE site.

The focus of this statement is on surface water, although groundwater and surface water are connected in most watersheds and activities affecting one of these resources can potentially affect the other. The watershed that is the focus of this statement would generally be a 6th-level (12 digit) watershed hydrologic unit code. The condition of the surrounding uplands can greatly affect the condition of a GDE. Changes in upland condition can influence the magnitude, timing, or duration of overland flow events, which could result in erosion or deposition of sediment in the GDE. The purpose of this indicator is to determine if activities within the watershed have adversely affected the feature. Although a correlation can exist, the focus here is on whether the uplands are contributing to degradation of the GDE, and not on the condition of the uplands.

Examples

This indicator would be answered “Yes” in the following circumstances:

- The site is receiving a normal range of surface flows, even if disturbance exists within its watershed.
- None of the adverse effects in the following list are observed.

This indicator would be answered “No” in the following circumstances:

- Upslope road ditches and cross drainage structures were installed in a manner that concentrates overland flows and shallow groundwater away from the site, causing desiccation of soils.
- Flow has been added from a diversion, and excessive erosion or deposition is taking place as a result of this increased flow.
- Trail development has intercepted, diverted, or concentrated overland flows initiating a headcut that is draining the site.
- Upslope road ditches, culverts, etc., are failing or in need of repair.

Water quality: Changes in water quality (surface or subsurface) are not affecting the GDE site.

GDEs are complex biogeochemical systems where water, nutrients, sediments, microclimate, and biota interact as part of the natural processes. The ecology of a GDE is affected by the quality of the water supporting the site. Changes in water quality can have detrimental effects on the flora and fauna. GDEs are susceptible to pollution from a number of activities. Pollutants may be toxic, which may harm or eliminate aquatic life. Inputs of nutrients (e.g., nitrogen, phosphorus) can increase the growth of aquatic vegetation and bacterial abundance and lower dissolved oxygen concentrations. These effects may cause intolerant macroinvertebrate communities to be replaced by communities that associated with impaired aquatic systems.

The geology of some watersheds naturally yields constituents (salts, iron, nutrients, calcium carbonates, etc.) that can inhibit growth for certain plant species. Examples of GDEs that have naturally limiting water quality conditions that favor some flora and fauna over others are thermal springs, travertine/tufa depositing springs, low pH springs, iron fens, and calcareous fens. Understanding the geology, soils, and water source is important to be able to accurately assess the causes of the water quality data. In some cases, unusual water chemistry values could be natural and, in other cases, they could be because of management activities.

Examples

This indicator would be answered “Yes” in the following circumstances:

- Water quality is within the expected range of variability.
- None of the adverse effects in the following list are observed.

This indicator would be answered “No” in the following circumstances:

- Data collected indicate poor water quality (requires knowledge of expected range of variability for the site).
- Sources of pollution such as mining waste or tailings, landfills, herbicides, pesticides, or accidental spills of hazardous chemicals and waste along roads exist.
- There has been excessive use by nonnative ungulates (such as wild horses and burros, cattle, and sheep) or native ungulates that have (1) deposited fecal matter and increased nutrients in the water or (2) damaged vegetation, allowing increased amounts of sediment and nutrients to enter the aquatic system.
- Sewage disposal on site, or sewage from off-site septic systems or lagoons has allowed pollutants to leach into the groundwater and move to springs along a hydraulic gradient.
- In some cases, excessive algae may be an indicator of nutrient loading in the water.
- Vegetation shows signs of stress from chemicals in the water.

Foul smells or discolored water should be further investigated to determine whether a water quality problem exists, or whether the foul smell is from natural anaerobic conditions and the discoloration is from a natural accumulation of organic matter.

If a problem is identified, water samples should be collected and analyzed and the results compared against relevant water quality criteria.

Landform stability: No evidence indicates human-caused mass movement or other surface disturbance affecting the GDE site stability.

In general, stable landforms are at a state of equilibrium with physical conditions and processes that affect a site such as climate, slope, soil, soil moisture, and geology. Anthropogenic disturbances in the watershed, including the GDE, can cause instability in landforms. The intent of this indicator is to identify activities or causes of landform instability at the GDE site.

Natural mass wasting can occur where groundwater discharges on a slope because geologic materials become saturated with water, the angle of repose is reduced to a very small value, and the material tends to flow like a fluid. This is because groundwater reduces grain-to-grain frictional contact. As a result, some discharge wetlands are associated with slope failures that are natural, but they could also be partially the result of management activities.

Examples

This indicator would be answered “Yes” in the following circumstances:

- Only natural mass movement, such as slumping, occurs.
- None of the adverse effects in the following list are observed.

This indicator would be answered “No” in the following circumstances:

- Excessive sediment deposition has occurred.
- Stream channel alteration has occurred, beyond what is natural.
- Streambank erosion or a headcut is affecting site stability.
- Slope failure has occurred from unnatural causes.
- A road cut or failing infrastructure (such as retaining walls, log cribs) is causing slope instability.

Runout channel: The channel, if present, is functioning naturally and is not entrenched, eroded, or otherwise substantially altered.

Runout channels from springs or wetlands support flora and fauna that are an important and often unique part of the biodiversity of a site, therefore the condition of the runout channel is important to assess. Changes in channel and bank morphology or substrate composition can alter habitat.

Runout channels are groundwater-fed streams that emerge from spring orifices (referred to as spring brooks or spring runs) or within groundwater-fed wetlands. Surface drainage areas to these springs can be very small, often much smaller than the recharge area of the springs. The major differences in controls on the channel morphology found between the spring-dominated and runoff-dominated channels are the discharge regime and the sediment input (Griffiths et al. 2008). The hydrology unique to spring-dominated channels and the lack of fine-grained sediment input combine to create the observed differences. Channels downstream of springs are typically straight, or, if sinuous, they are without regularity to the pattern. Bars are absent or poorly defined, but islands or downed timber is common in the channel. Springflow-dominated channels are a special habitat of running waters because of the relatively uniform temperature and the deoxygenated groundwater contribution to the stream (Springer and Stevens 2009). Springflow-dominated systems may be sufficiently stable habitats to allow for evolutionary microadaptation and, ultimately, speciation (McCabe 1998).

Examples

This indicator would be answered “Yes” in the following circumstances:

- The runout channel is functioning naturally.
- None of the adverse effects in the following list are observed.

This indicator would be answered “No” in the following circumstances:

- Bank morphology has been changed by ungulate trampling, vehicles, or other activities.
- Channel morphology has been changed by excavation, ditching, or redirection.

- The channel is entrenched.
- Erosion of streambanks is beyond the natural range that would be expected at the site.

Soil integrity: Soils are intact and functional. For example, saturation is sufficient to maintain hydric soils, if present; there is not excessive erosion or deposition.

The purpose of this indicator is to evaluate the condition of the soil and to determine if the soil has been affected by excessive disturbance. Management activities can alter the soil and the hydrologic conditions that affect the soil. In the case of wetlands, intact hydric soils are a useful indicator that the duration and frequency of saturation has been sufficient to maintain wetland soil characteristics. Soil saturation creates anaerobic conditions, which leads to the reduction, translocation, and accumulation of iron, manganese, sulfur, and carbon compounds (redoximorphic features). Saturation also slows decomposition of plant material, which can lead to the accumulation of peat (over long-term periods). This soil integrity indicator is intended to assess whether such hydric soils are being maintained in those areas where hydric soils would be expected. In the case of springs without hydric soils, the intent is to determine if soil disturbance (erosion, deposition, compaction, etc.) has occurred.

Examples

This indicator would be answered “Yes” in the following circumstances:

- Hydric soils are present and soil saturation is close to the ground surface.
- None of the adverse effects in the following list are observed.

This indicator would be answered “No” in the following circumstances:

- Soil compaction or erosion because of livestock, vehicles, or other sources.
- Desiccated peat or oxidized organic matter is observed at the site.

- Peat soils are churned because of livestock hoof action. (This refers to the stirring of the peat layer that causes organic matter to be mixed into the underlying mineral layer. The soil structure is altered and is massive or platy.)
- Pedestals created by hoof shear, hoof compaction, and disruption of root systems.
- Post holes/puddling that result from logging equipment, recreational vehicles, livestock, and wildlife.

***Vegetation composition:* The site includes anticipated cover of plant species associated with the site environment, and no evidence suggests that upland species are replacing hydric species.**

Vegetation composition is an expression of environmental conditions and management activities. The abundance of plant species will respond to changes in hydrologic conditions at a GDE. In some cases, certain species disappear altogether from a site because of changes in water table or spring flow. Vegetation composition can also change because of disturbances and management activities. The relatively consistent availability of water at GDEs supports hydric plants, which are generally more abundant at GDEs than in the surrounding uplands.

Examples

This indicator would be answered “Yes” in the following circumstances:

- Expected vegetation for the setting and environment is present, which would generally include OBL or FACW species of the Wetland Indicator Status (USFWS 1988). Primarily native species.

This indicator would be answered “No” in the following circumstances:

- Wetland vegetation seems to have been greatly reduced or eliminated.
- Overstory of wetland woody species but a lack of wetland understory species, suggesting recent hydrologic changes (because herbaceous vegetation is generally more responsive to changes in hydrology than woody species).

- Evidence suggesting that upland species have increased.
- Dominance by nonnative or invasive plants.

Vegetation condition: Vegetation exhibits seasonally appropriate health and vigor.

This statement is intended to evaluate the health or vigor of the vegetation, based on a visual assessment. The condition of vegetation can be adversely affected by management activities.

Examples

This indicator would be answered “Yes” in the following circumstances:

- Sites that have dense, robust vegetation growth that is healthy-looking in terms of leaf color, size, and shape.

This indicator would be answered “No” in the following circumstances:

- Sites that have discolored, decadent, weakened, or unusually sparse vegetation.
- Evidence of severe grazing or browsing by livestock and/or native ungulates, such as hedged plants.

Threatened, endangered, and sensitive species; SOI/SOC; or focal floral species. Anticipated floral species are present (will vary by ecological region and will require some baseline information).

Some GDEs support threatened, endangered, or sensitive species; SOI/species of concern (SOC); or focal floral species. The intent of this indicator is to identify sites that support these important plant species.

GDEs can be floristically diverse, supporting a large number of rare and uncommon vascular plant species and bryophytes. GDEs can be unique habitats that support a higher level of biodiversity than the surrounding landscape. An array of plant species is known to be endemic to, or inhabit, these locations.

Examples

This indicator would be answered “Yes” in the following circumstances:

- Threatened, endangered, or sensitive species; SOI/SOC; or focal floral species were observed at a site whether or not they had been identified at the site before.
- No threatened, endangered, or sensitive species; SOI/SOC; or focal floral species were observed and none were anticipated.

This indicator would be answered “No” in the following circumstances:

- Threatened, endangered, or sensitive species; SOI/SOC; or focal floral species were not observed at a site but had been documented at the site previously.
- Threatened, endangered, or sensitive species; SOI/SOC; or focal floral species were expected to be at the site but were not observed.

Faunal species: Anticipated aquatic and terrestrial faunal species associated with the site environment are present.

Some GDEs have habitats that support aquatic and terrestrial faunal species. The intent of this indicator is to identify sites that support important animal species.

Wetlands support many different types of animals, including invertebrates, fish, amphibians, reptiles, birds, and mammals. Because of the transitional nature of wetlands, both aquatic and terrestrial animals live in wetlands. Wetlands provide food sources, protection from weather and predators, resting sites, reproductive sites, and molting grounds for wildlife (Cooper 1989). Wetlands provide this habitat function for many species of fish and wildlife, including some that are threatened or endangered. Many species of animals that are not typically considered to be wetland species also use wetlands.

Examples

This indicator would be answered “Yes” in the following circumstances:

- Anticipated faunal species were observed at a site, whether or not they had been identified at the site before.
- No faunal species were anticipated, and none were observed.

This indicator would be answered “No” in the following circumstances:

- Anticipated faunal species were not observed at a site but they had been documented at the site previously.
- Faunal species were anticipated to be at the site but they were not observed.

Threatened, endangered, or sensitive species; SOI/SOC; or focal faunal species: Anticipated faunal species are present (will vary by ecological region and will require some baseline information).

GDEs can be unique habitats that support a higher level of biodiversity than the surrounding landscape. An array of threatened, endangered, or sensitive species; SOI/SOC; or focal faunal species is known to be endemic to, or use, GDEs. The intent of this indicator is to identify sites that support important animal species.

Examples

This indicator would be answered “Yes” in the following circumstances:

- Threatened, endangered, or sensitive species; SOI/SOC; or focal faunal species were observed, whether or not they had been identified at the site before.
- No threatened, endangered, or sensitive species; SOI/SOC; or focal faunal species were anticipated, and none were observed.

This indicator would be answered “No” in the following circumstances:

- Threatened, endangered, or sensitive species; SOI/SOC; or focal faunal species were not observed but had been documented at the site previously.
- Threatened, endangered, or sensitive species; SOI/SOC; or focal faunal species were expected to be at the site but were not observed.

Invasive species: Invasive floral and faunal species are not established at the site.

Invasive plant and animal species have a detrimental effect on the ecological functioning of GDEs. This statement asks if invasive animal or plant species have become established at the site. It is useful to know where invasive species have been established, so that controls can be implemented. Identifying the occurrence of invasive species before they infest a site is useful information.

Various characteristics of invasive species allow them to displace native vegetation at sites that have been disturbed by water impoundments, excessive grazing, recreation, and other activities. By displacing native vegetation, they reduce habitat that formerly provided critical nesting, feeding, and spawning habitat for wildlife species. A number of nonnative vertebrates and invertebrates have been introduced into springs in Western North America, and in some cases, populations of native aquatic species have either been reduced or extirpated as a result.

Some plant species that are considered to be invasive in springs or wetlands, at least in some States, include purple loosestrife, tamarisk, common reed, reed canarygrass, and many others. Invasive animals could include the zebra mussel and many others.

Examples

This indicator would be answered “Yes” in the following circumstances:

- No invasive species (or very few individuals) were observed at the site.

This indicator would be answered “No” in the following circumstances:

- Invasive animal or plant species are established at the site.

Lists of invasive plants can be obtained for States and many counties or on line at <http://plants.usda.gov/java/noxiousDriver>.

Flow regulation: Flow regulation is not adversely affecting the site.

Alteration of surface or subsurface flow patterns may affect the functionality of a site. This statement is intended to determine if flow regulation has occurred at the site, which can have significant effects on the biota. For areas where wetland vegetation is important, a change in flow patterns may mean a change in vegetation type (wetland species to upland species), creating a site unable to function properly. For others, it may mean a decrease in extent of wetland or complete wetland loss.

Effects of diversion are similar to the consequences of a drought that causes springs and wetlands to become drier. In general, species richness declines as diversion increases, and functional shifts in the structure of aquatic and wetland communities occur. As diversion increases, intolerant aquatic taxa (e.g., mayflies, caddisflies, crenobiontics) are replaced by tolerant taxa (e.g., midges, beetles, corixids), and nonnative and upland vegetation becomes more abundant.

Examples

This indicator would be answered “Yes” in the following circumstances:

- No flow regulation exists at the site.
- Flow regulation structures are stable, accommodate flows, and do not adversely affect the ecology of the site.
- Diversions remove very small amounts of water and have minimal effects on ecology.

This indicator would be answered “No” in the following circumstances:

- There exists channelization or redirection of flow, delivery of water through pipes and concrete channels to tanks and

reservoirs, excavation and installation of spring boxes, ditching wetlands to drain them, or impounding spring sources. (These structures are designed to capture and divert water for uses such as livestock watering, domestic use, or irrigation.)

- Flow diversion is causing the area of wetland vegetation and soils to contract.

Construction and road effects: Construction, reconstruction, or maintenance of physical improvements, including roads, are not adversely affecting the site.

Roads can cause negative ecological effects to ecosystems, plants, and wildlife. The effects of road construction and operation on wetlands and springs include negative effects from changes to the chemistry and biology of the local area to changes in hydrology that go beyond the immediate area of the road. Loss of wildlife habitat, loss of species, and biodiversity are other consequences of such changes. In addition, roads are barriers that can cause habitat fragmentation and edge effects, which may affect some plant and animal species. Roads are also corridors that can facilitate the spread of invasive species.

Examples

This indicator would be answered “Yes” in the following circumstances:

- No evidence suggests that construction or roads are affecting the GDE.

This indicator would be answered “No” in the following circumstances:

- Within the site, roads have caused trampling, soil compaction, erosion, disturbance (because of noise or motion), pollution, nutrient loading, or introduction of invasive plant species.
- Road is channelizing runoff and delivering sediment to the site.
- Physical improvements, such as buildings, latrines, water development structures, piping, and parking lots, are affecting the site.
- Stormwater runoff from a road or parking lot is entering a wetland.

Fencing effects: Protection fencing and enclosures are appropriate and functional.

Fences are sometimes used to exclude animals or people from spring or wetland sites to prevent damage to vegetation, alteration of sediment flux, or adverse effects on water quality. Proper placement and maintenance of fences is required to meet conservation objectives. This indicator assesses if the fences are appropriately designed, located, and maintained, and if they are working as intended.

Examples

This indicator would be answered “Yes” in the following circumstances:

- Fencing was properly designed and is functioning to exclude whatever it was intended to exclude, such as livestock, wild animals, vehicles, and recreation use.

This indicator would be answered “No” in the following circumstances:

- Fence is down, damaged, or broken.
- Fence was not designed or constructed in a manner that effectively protects the ecologically valuable portions of the site.

Herbivore effects: Herbivory is not adversely affecting the site.

This indicator documents whether grazing or browsing by native or nonnative animals is adversely affecting the site. This refers to effects from animals such as cattle, sheep, horses, burros, elk, deer, or moose.

Many springs and wetlands have been altered by grazing and trampling of livestock, as well as other nonnative and native ungulates. Excessive grazing in GDEs can damage or alter vegetation, lead to increased water temperature, cause soil erosion (including streambank erosion), and add sediment and nutrients to aquatic systems. Those changes can damage habitat for wildlife, fish, and other aquatic fauna, such as macroinvertebrates.

Examples

This indicator would be answered “Yes” in the following circumstances:

- No evidence indicates adverse effects from grazing or browsing by native or nonnative ungulates.

This indicator would be answered “No” in the following circumstances:

- Native or nonnative ungulates have caused excessive removal of vegetation, abnormally low height (including hedging of shrubs) or cover of vegetation, or major changes in species composition.
- Native or nonnative ungulates’ hoof action has caused trampling of vegetation, soil erosion, or other ground disturbance.

Recreational effects: Recreational uses, including trails, are not adversely affecting the site.

Recreational activities can negatively affect GDEs. Off-road vehicle use is increasing on NFS lands and has damaged many wetland and spring habitats. Sada (2001) documented how trampling by recreationists affected the abundance and distribution of spring-dwelling mollusks. The effects on springs is similar to those caused by excessive livestock and wildlife activity in riparian and aquatic systems, where it has degraded riparian vegetation and increased water temperature, the amount of fine substrates, and nutrient loading (Fleischner 1994, Kauffman and Krueger 1984).

Examples

This indicator would be answered “Yes” in the following circumstances:

- None of the adverse effects in the following list are observed.

This indicator would be answered “No” in the following circumstances:

- Camping, hiking, and associated refuse have adversely affected the site.
- Recreation use along a spring brook has caused decreased vegetation height or cover (through trampling or other damage).

- Vehicles have caused erosion, soil compaction, damage to vegetation, or other adverse effects.
- Other recreational activities (trails, horseback riding, etc.) have adversely affected the site.

Other disturbance effects: Wildland fire, insect, disease, wind throw, avalanches, or other disturbances are not adversely affecting the site.

This indicator documents adverse effects from disturbances not captured in other statements, such as fire, blow down, pest infestation, disease, and avalanches.

Examples

This indicator would be answered “Yes” in the following circumstances:

- None of the adverse effects in the following list have had a significant adverse affect on the site.

This indicator would be answered “No” in the following circumstances:

- Significant amounts of dead or dying vegetation (particularly trees and shrubs) from insect infestation, disease, or wildfire are found in the site.
- Evidence suggests that blow down, pest infestation, disease, avalanches, debris flow, or other natural disturbances have had a significant adverse affect on the site.

Cultural values: Archaeological, historical, or tribal values will not affect inventory, restoration, use, or management of this site.

Many springs, particularly in the Southwestern United States, have cultural and or historical significance that could require consultation with tribes or State historic preservation offices.

Examples

This indicator would be answered “Yes” in the following circumstances:

- No evidence indicating archaeological, historical, or tribal resources at the site.

This indicator would be answered “No” in the following circumstances:

- Archaeological, historical, or tribal resources could be affected by inventory, restoration, use, or management of the site.
- Site sacredness is recognized by tribes or nontribal agencies.
- Site has potential for *National Register of Historic Places* status.
- Artifacts, petroglyphs, ruins, water works, or dwelling sites are present.

Land ownership: The entire site and immediate area are under the jurisdiction and management of the Forest Service.

This indicator simply documents that the site is managed by the Forest Service and, thus, the land manager has the authority to control undesirable or unauthorized activities at the site.

Examples

This indicator would be answered “Yes” in the following circumstances:

- Entire site is within Forest Service jurisdiction.

This indicator would be answered “No” in the following circumstances:

- Part, or all, of the site is not within Forest Service jurisdiction.

Other landowner actions: Activities or management on lands outside Forest Service jurisdiction are not adversely affecting the site.

This indicator documents whether the site is under threat from actions by adjacent landowners.

Examples

This indicator would be answered “Yes” in the following circumstances:

- None of the adverse effects in the following list are observed.

This indicator would be answered “No” in the following circumstances:

- A large pumping well is located adjacent to the site, off of NFS lands, and is dewatering the site.
- Other activities off of NFS lands are adversely affecting the site.

Land management plan: The land and resource management plan provides for effective site protection.

Forest or grassland plans define desired conditions or standards and guidelines for management of forest resources.

Examples

This indicator would be answered “Yes” in the following circumstances:

- The forest or grassland plan states that springs and wetlands are managed to promote long-term viability of ecological function.

This indicator would be answered “No” in the following circumstances:

- The forest plan does not recognize that springs and wetlands are managed to promote long-term viability of ecological function.

Environmental compliance: Authorized and administrative uses are in compliance and are not adversely affecting the site.

Water developments are authorized under special-use authorization regulations. This indicator is used to alert the land manager of unauthorized activities that need to be addressed.

Examples

This indicator would be answered “Yes” in the following circumstances:

- None of the adverse effects in the following list are observed.

This indicator would be answered “No” in the following circumstances:

- A water development was not constructed as specified in the permit.
- Grazing within the site is not in compliance with allotment management plan requirements.

Water Uses: There are no substantial water uses in the watershed or in the aquifer supplying groundwater to the site that could directly or cumulatively adversely affect the GDE.

The purpose of this indicator is to assess the scope and extent of water use (including that from water rights) within the watershed and/or aquifer to assess the potential for direct or cumulative adverse affects to the GDE.

Water use from surface or groundwater sources should be accounted for under either State or Federal authority. All water use, whether exempt from State application procedures or not, needs to be properly documented and tracked relative to the amount of water used and location of withdrawal and use. Information from the Water Rights and Uses (WRU) database/site visit field form, which can be included in the GDE inventory process, is used to assess if there is substantial water use, individually or cumulatively, from water uses.

Examples

This indicator would be answered “Yes” in the following circumstances:

- The density of water uses and rights is small relative to streamflow availability or aquifer capacity.
- Water uses and water rights that affect the site have been inventoried and accounted for and are being used as intended and within the limits of the right or exemption.
- Infrastructure adjacent to the site or within the watershed has evidence of maintenance and is functioning well.

This indicator would be answered “No” in the following circumstances:

- The density of water uses and rights is moderate to high relative to streamflow availability or aquifer capacity.
- Water uses and water rights have not been inventoried; many uses are unidentified or unknown, with little to no information on amount or frequency of use.
- Infrastructure adjacent to site or within the watershed is extensive, with no inventory information to assess the extent of infrastructure and water use.

Water Rights: Water rights have been filed for the site under State law or water uses exempted under State law are documented. Forest Service Federal reserved rights are documented as appropriate. Third-party water use is in accordance with all elements of the water right or conditions of the exemption and with the Forest Service authorization that allows the use.

The purpose of this indicator is to assess the water rights and uses disposition of the site (see description under the previous “water uses” section). Information from the WRU database and site visit field form, which can be included in the GDE inventory process, is used to assess if there is substantial water use, individually or cumulatively, from water uses.

Examples

This indicator would be answered “Yes” in the following circumstances:

- A reasonable amount of water is being consumed for the specific purpose. Amount and timing of water withdrawal is comparable to similar uses at sites/watersheds with similar conditions.
- If metered, metering is accurate and measurements are used in assessments.
- The water right or use is valid and used in accordance to specifications of the right or use.
- Infrastructure and diversions are in good working condition.

This indicator would be answered “No” in the following circumstances:

- Water right or use is in violation of exemptions and is not authorized under State law or subject to forfeiture.
- Water is not metered and is required to be metered under State law or special-use permit.
- Infrastructure is not maintained and water use is not controlled.

Post-Field Survey Activities (in office)

After the field survey, additional activities need to be completed in the office or laboratory to supplement or enhance the field data. These activities are described in the following list (in the same manner they are listed in the “Using the Level I Field Guide” section in the beginning of this field guide).

Obtain or Verify Data

Based upon the location data (UTM or latitude/longitude) acquired at the site, the following are examples of attributes that can be determined, verified, or updated in the office, primarily with GIS tools.

- Watershed(s) hydrologic unit codes.
- Ecological system.
- Local feature-type name.
- Site name (an existing site name that was not known at the field visit may exist).
- Primary lithology (groundwater source aquifer).
- Secondary lithology.

Laboratory Analyses

If samples or specimens were collected in the field, then they need to be transferred to a location where they can be analyzed. Plant specimens should be taken to a botanist or herbarium for identification. Macroinvertebrate specimens should be sent to a laboratory that follows general processing and identification guidelines for identification (described in the Lab Identification part of the Aquatic Macroinvertebrates section). Water samples and soil samples should be sent to a laboratory that follows standardized guidelines of quality assurance.

Implement Data Management and Interpretation Procedures

Field data recorded either on paper forms or field data recorders will need to be entered into the corporate database. A significant amount of time needs to be allotted for data entry from paper forms. The database can generate summaries for each attribute and those should be reviewed for obvious errors that might have been made in recording or entering the data. A site summary can be generated in the database as well, which includes all of the attributes and the basic site information.

Photos taken with a digital camera need to be downloaded, labeled, and stored in a location that is associated with the other site information. Handwritten materials such as drawings and notes should be scanned into electronic format and stored in a location that is associated with the other site information.

Validate and Confirm Management Indicator Tool Entries

The responses to the Management Indicator Tool should be compared to the summarized field data in the office. This will either confirm the field responses or provide information that can be used to edit the field responses. For example, it may have been noted that there were no invasive species at the site, but the summarized data in the office may indicate that there were indeed significant amounts of invasive plants or animals. The response to the statement on invasive species would then be updated based on the summarized field data.

Analyze and Evaluate Collected Information

Detailed techniques for analyzing and evaluating the data collected with this field guide are not described in this field guide.

Glossary

Some definitions are taken from Mitsch and Gosselink (2007).

anoxia—Waters or soils with no dissolved oxygen.

aquifer—A saturated underground layer of water-bearing permeable rock or unconsolidated materials (gravel, sand, silt, or clay) from which groundwater can be extracted using a well. An aquifer can be confined, unconfined, or partially confined. The aquifer can be perched, local, or regional. Aquifers are connected to the hydrologic cycle through recharge, within and between unit flow, and through discharge.

artesian—Condition in which a confined aquifer is under pressure such that the static level within a cased borehole rises above an impermeable (confining) layer (e.g., peat layer) or in which water discharges to the surface from an unlined borehole.

base-flow stream—A perennial stream supported by groundwater discharge during periods of low or no precipitation or snowmelt.

bog—A peat-accumulating wetland that has no significant inflows or outflows and supports acidophilic mosses, particularly *Sphagnum*. In general, bogs are supported by precipitation.

bryophytes—Nonvascular land plants (mosses, liverworts, and hornworts) that have tissues and enclosed reproductive systems but lack vascular tissue that circulates liquids. They neither have flowers nor produce seeds because they reproduce via spores.

Carolina Bay—Elliptical depressions or shallow basins that occur throughout the Southeastern United States Coastal Plain. Their hydrology is dominated by precipitation inputs and evapotranspiration losses, and they range from nearly permanently inundated to frequently dry.

cave—A natural underground space formed by various geologic processes. Caves are common in **karst** terrain and areas of psuedokarst.

ciénega—Usually a wet, marshy area at the foot of a mountain, in a canyon, or on the edge of a grassland where groundwater reaches the surface. Often, a ciénega does not drain into a stream but instead evaporates. Also called **helocrene**.

crenobiontic—Organisms that live only in springs.

exposure spring (one of the spheres of discharge, as described by Springer and Stevens 2009)—Groundwater is exposed at the land surface but does not have surface inflow or outflow. Exposure springs occur in **karst** (sinkholes) and psuedokarst (lava flows) but could form in other types of vertical conduits into an aquifer.

fen—In general, wetlands that develop where a relatively constant supply of groundwater to the plant rooting zone maintains saturated conditions most of the time and the water chemistry reflects the mineralogy of the surrounding and underlying soils and geological materials. The U.S. Fish and Wildlife Service (1999) uses two criteria to classify a wetland as a fen: (1) the wetland is primarily supported by groundwater and (2) the wetland has organic soils meeting the U.S. Department of Agriculture, Natural Resources Conservation Service (2010) definition of a **histosol** or a **histic epipedon** in at least some part of the contiguous wetland.

fibric—Organic soil material that contains 3/4 or more recognizable fibers (after rubbing between fingers) of undecomposed plant remains. Bulk density is usually very low and water-holding capacity very high. Also referred to as **peat**.

flark—See **string and flark microtopography**.

forb—Herbaceous flowering plant that is not a graminoid.

fountain spring (one of the spheres of discharge, as described by Springer and Stevens 2009)—Cool, **artesian** springs that are forced above the land surface by artesian or gas pressure.

geyser (one of the spheres of discharge, as described by Springer and Stevens 2009)—Geothermal springs that emerge explosively and usually erratically. A geyser is a hot spring characterized by intermittent discharges of water that are ejected turbulently by a vapor phase.

graminoid—True grasses (*Poaceae*) or grass-like plants, such as sedges (*Cyperaceae*) or rushes (*Juncaceae*).

groundwater—All water below the ground surface, including water in the saturated and unsaturated zones.

groundwater-dependent ecosystems (GDEs)—Communities of plants, animals, and other organisms whose extent and life processes are dependent on access to or discharge of **groundwater**.

gushet (one of the spheres of discharge, as described by Springer and Stevens 2009)—Discrete sources of flow pouring from cliff faces. Gushets typically emerge from perched, unconfined **aquifers**, often with dissolution enhancement along fractures, exhibit thin sheets of water flowing over rock faces.

hanging garden or wet wall (one of the spheres of discharge, as described by Springer and Stevens 2009)—Springs that emerge along geologic contacts or fractures and seep, drip, or pour onto underlying walls. Hanging gardens in the Southwestern United States typically emerge from perched, unconfined aquifers in Aeolian sandstone units.

helocrene (one of the spheres of discharge, as described by Springer and Stevens 2009)—Low-gradient springs and/or wetlands; often indistinct or multiple sources of groundwater. Also called **wet meadows** or **ciénegas**.

hemic—Organic soil material at an intermediate degree of decomposition that contains 1/6 to 3/4 recognizable fibers (after rubbing between fingers) of undecomposed plant remains. Bulk density is usually very low and water-holding capacity very high. Also referred to as **mucky peat**.

herbaceous—A plant that has leaves and stems that die down to the ground at the end of the growing season. They have no persistent woody stems.

hillslope (one of the spheres of discharge, as described by Springer and Stevens 2009)—**Springs** and/or **wetlands** on a hillslope (generally 20- to 60-degree slope), often with indistinct or multiple sources of **groundwater**.

histic epipedon—An 8- to 16-inch layer at or near the surface of a mineral hydric soil that is saturated with water for 30 consecutive days or more in most years and contains a minimum of 20 percent organic matter when no clay is present or a minimum of 30 percent organic matter when clay content is 60 percent or greater. Soils with histic epipedons are inundated or saturated for sufficient periods to greatly retard aerobic decomposition of the organic surface and are considered to be hydric soils.

histosol—Histosols (**organic soils**) develop under conditions of nearly continuous saturation and/or inundation. All histosols are hydric soils except folists, which are freely drained soils occurring on dry slopes where excess litter accumulates over bedrock. Organic hydric soils are commonly known as **peats** and **mucks**.

hypocrene (one of the spheres of discharge, as described by Springer and Stevens 2009)—A buried spring where flow does not reach the surface. This term is common to the Southwestern United States. Elsewhere, these features may be equivalent to shallow groundwater areas, including **fens**.

hyporheic zone—Area of a stream bed and bank where surface and ground waters mix. A similar area, the hypolentic zone, exists in lakes and ponds.

insurgence—The point of inflow for surface water into subsurface conduits in **karst** areas.

jurisdictional wetlands—Those areas that are inundated or saturated by surface or ground water (hydrology) at a frequency and duration sufficient to support and that, under normal circumstances, do support a prevalence of vegetation (hydrophytes) typically adapted for life in saturated soil conditions (hydric soils). Wetlands generally include swamps, marshes, bogs, and similar areas (40 Code of Federal Regulations 232.2(r)).

karst—A terrain or type of topography generally underlain by soluble rocks, such as limestone, gypsum, and dolomite, in which the topography is chiefly formed by dissolving the rock; karst is characterized by sinkholes, depressions, caves, and underground drainage. Psuedokarst is an area of depressions, caves, and internal drainage that result from volcanic activity.

limnocrene (one of the spheres of discharge, as described by Springer and Stevens 2009)—Groundwater emerges in one or more pools.

marsh—A frequently or continually inundated **wetland** characterized by emergent herbaceous vegetation adapted to saturated soil conditions.

mineralized mounds (one of the spheres of discharge, as described by Springer and Stevens 2009)—**Springs** that emerge from (usually carbonate) precipitate mounds.

minerogenous—See **minerotrophic peatlands**.

minerotrophic peatlands—Peatlands that receive water that has passed through mineral soil. Also called minerogenous hydrological systems.

muck—Organic soil material in which the original plant parts are not recognizable. Contains more mineral matter and is usually darker in color than peat. Also referred to as **sapric** material.

mucky peat—Organic soil material in which a significant part of the original plant parts are recognizable and a significant part is not. Also referred to as **hemic** material.

National Resource Manager (NRM)-Automated Lands

Program (ALP) database—The Forest Service national ALP is an information management system that contains all land status data for Forest Service managed land, including land survey, ownership, use restrictions, and boundaries.

NRM-Infrastructure (INFRA) database—NRM-INFRA is a Forest Service data management system that includes a collection of Web-based data entry forms, reporting tools, and Geographic Information System tools that enable forests to manage and report accurate information about their inventory of constructed features and land units as well as permits sold to the general public and to partners.

NRM-Natural Resource Information System (NRIS) Water Rights and Uses database—The NRIS is a set of Forest Service corporate databases and computer applications that contain basic natural resource data. The Water Rights and Uses database tracks core information about State and federally recognized water rights and uses. It also tracks related information about beneficiaries, purpose, quantity, and periods of water use.

ombrogenous—Peatland with inflow from precipitation only. Also called ombrotrophic.

organic soil—Organic soils (**histosols**) develop under conditions of nearly continuous saturation and/or inundation. All organic soils are hydric soils except folists, which are freely drained soils occurring on dry slopes where excess litter accumulates over bedrock. Organic hydric soils are commonly known as **peats** and **mucks**.

peat—Organic soil material that is undecomposed or weakly decomposed. The plant remains are distinct and identifiable.

peatland—A generic term for any **wetland** that accumulates partially decayed plant matter (**peat**).

phreatophyte—Plant whose roots generally extend downwards to the water table and customarily feed on the capillary fringe. Phreatophytes are common in **riparian** habitats. Term literally means “well” plant or water-loving plant.

piezometer—Small-diameter well open at a point or over a short length in the aquifer to allow measurement of hydraulic head at that location.

pocosin—Peat-accumulating, nonriparian freshwater wetland, generally dominated by evergreen shrubs and trees and found on the Southeastern Coastal Plain of the United States. The term comes from the Algonquin word for “swamp on a hill.”

redoximorphic features—Features formed by the reduction, translocation, and/or oxidation of iron and manganese oxides; used to identify hydric soils.

rheocrene (one of the spheres of discharge, as described by Springer and Stevens 2009)—Flowing springs that emerge directly into one or more stream channels.

riparian—Pertaining to the bank of a body of flowing water; the land adjacent to a river or stream that is, at least periodically, influenced by flooding. Riparian sometimes is used to indicate the banks of lakes and ponds subject to period inundation by wave action or flooding.

sapric—Organic soil material that contains less than one out of six recognizable fibers (after rubbing between fingers) of undecomposed plant remains. Bulk density is usually very low, and water holding capacity very high. Also referred to as **muck**.

seep—A discharge of water that oozes out of the soil or rock over a certain area without distinct trickles or rivulets.

specific conductance—A measure of an aqueous solution’s ability to carry an electrical current (also called electrical conductance or conductivity).

spring—A place where groundwater flows naturally from the earth into a body of surface water or onto the land surface.

spring brook—Runout channel from a **spring**, which may become a stream at some distance from the spring source.

spring source—The location where the spring emerges from the ground onto the land surface. Also referred to as the spring orifice.

string and flark microtopography—Slow groundwater movement through broad, gently sloped **peatlands** forms a series of linear hummock ridges called strings, separated by parallel hollows known as flarks. Strings and flarks are arranged perpendicularly to the flow of water through the peatland and can form a regular pattern of parallel ridges and hollows or an intricate, braided or branching (anastomosing) pattern.

swamp—**Wetland** dominated by trees or shrubs.

Terrestrial Ecological Unit Inventory (TEUI)—The national program of ecological classification within the Forest Service that was developed to classify ecological types and map ecological units to a consistent standard across National Forest System lands. TEUI establishes terrestrial mapping units derived from a combination of core datasets, which uniquely characterize a spatial region, including climate, geology, geomorphology, soil regime, and vegetation.

upland—Land that is not influenced by a consistent source of surface water or groundwater and, therefore, does not support **wetland** vegetation or hydric soil development as would a wetland or **riparian** area.

wet meadow—Area that is saturated with water for much of the year but does not have standing water, except for brief periods, during the growing season.

wetland—In general, wetlands are lands on which water covers the soil or is present either at or near the surface of the soil or within the root zone, all year or for varying periods of time during the year, including during the growing season. The U.S. Fish and Wildlife Service defines wetlands as “lands that are transitional between terrestrial and aquatic systems where the water table is usually at or near the surface or the land is covered by shallow water... (and) have one or more of the following attributes: (1) at

least periodically, the land supports predominantly hydrophytes; (2) the substrate is predominantly undrained hydric soil; or (3) the substrate is nonsoil and is saturated with water or covered by shallow water at some time during the growing season of each year” (Cowardin et al. 1979). See also **jurisdictional wetland**.

wetland indicator status—A system of categorizing plant species in terms of their probability of occurring in **wetlands**. The system was developed by the U.S. Fish and Wildlife Service (1988). It has five general categories: obligate, facultative wetland, facultative, facultative upland, and upland. Obligate species almost always occur in wetlands, whereas upland species almost never occur in wetlands, as described in table 4.

Table 4.—*Wetland indicator status codes and descriptions (USWFS 1988).*

Wetland indicator status	Code	Estimated probability a species occurs in wetlands
Obligate	OBL	Almost always (99%)
Obligate –	OBL –	
Facultative wetland +	FACW +	
Facultative wetland	FACW	Usually (67–99%)
Facultative wetland –	FACW –	
Facultative +	FAC +	
Facultative	FAC	Equally likely to occur in wetlands or nonwetlands (34–66%)
Facultative –	FAC –	
Facultative upland +	FACU +	
Facultative upland	FACU	Not usually (1–33%)
Facultative upland –	FACU –	
Upland +	UPL +	
Upland	UPL	Almost never (1%)

References

- Baas-Becking, L.G.M.; Kaplan, I.R.; Moore, D. 1960. Limits of the natural environment in terms of pH and oxidation-reduction potentials. *Journal of Geology* 68: 243–284.
- Brohman, R.J.; Bryant, L.D., eds. 2005. Existing vegetation classification and mapping technical guide. Version 1.0. Washington, DC: U.S. Department of Agriculture, Forest Service, Ecosystem Management Coordination Staff. 305 p.
- Brown, J.; Wyers, A.; Aldous, A.; Bach, L. 2007. Groundwater and biodiversity conservation: a methods guide for integrating groundwater needs of ecosystems and species into conservation plans in the Pacific Northwest. Portland, OR: The Nature Conservancy. 184 p.
- Cowardin, L.M.; Carter, V.; Golet, F.C.; LaRoe, E.T. 1979. Classification of wetlands and deepwater habitats of the United States. Washington, DC: U.S. Department of the Interior, Fish and Wildlife Service. 131 p.
- Fleischner, T.L. 1994. Ecological costs of livestock grazing in Western North America. *Conservation Biology*. 8: 629–644.
- Griffiths, R.E.; Springer, A.E.; Anderson, D.E. 2008. The morphology and hydrology of small spring-dominated channels. *Geomorphology*. 102: 511–521.
- Gurrieri, J. 2007 (draft). Interim protocol, ground-water resource inventory and monitoring protocol, level I spring ecosystem inventory. Ogden, UT: U.S. Department of Agriculture, Forest Service, Intermountain Region. 35 p.
- Hall, F.C. 2001. Photo point monitoring handbook, part A—field procedures. PNW-GTR-526. Portland, OR: U.S. Department of Agriculture, Forest Service, Pacific Northwest Research Station. 340 p.
- Haskins, D.M.; Correll, C.S.; Foster, R.A.; et al. 1998. A geomorphic classification system. Washington, DC: U.S. Department of Agriculture, Forest Service. 110 p.

Johnston, B.C.; Almy, J.; Stratton, B. 2009 (draft). Study plan: sampling of the polygons photointerpreted for possible fens on the Grand Mesa-Uncompahgre-Gunnison National Forest, Colorado. Delta, CO: U.S. Department of Agriculture, Forest Service, Grand Mesa-Uncompahgre-Gunnison National Forest. 23 p.

Kauffman, J.B.; Krueger, W.C. 1984. Livestock impacts on riparian ecosystems and streamside management implications: a review. *Journal of Range Management*. 37: 430–437.

Langmuir, D. 1996. *Aqueous environmental geochemistry*. Upper Saddle River, NJ: Prentice-Hall. 600 p.

Magee, T.K.; Dwire, K.A.; Gwin, S.E.; et al. 1995. Field and laboratory operations report for the Oregon Wetlands Study. Corvallis, OR: U.S. Environmental Protection Agency, Environmental Research Laboratory. 206 p.

McCabe, D.J. 1998. Biological communities in springbrooks. In: Botosaneanu, L., ed. *Studies in crenobiology: the biology of springs and springbrooks*. Leiden, The Netherlands: Backhuys Publishers: 221–228.

Mitsch, W.J.; Gosselink, J.G. 2007. *Wetlands*. 4th ed. New York: John Wiley and Sons. 582 p.

National Wetlands Working Group. 1997. *The Canadian wetland classification system*. Waterloo, Ontario: University of Waterloo, Wetlands Research Centre. 76 p.

NatureServe. 2011. *International ecological classification standard: terrestrial ecological classifications*. Arlington, VA: NatureServe Central Databases. <http://www.natureserve.org/getData/USecologyData.jsp>. (12 May 2011).

Prichard, D. 2003. A user guide to assessing proper functioning condition and the supporting science for lentic areas. Rev. TR 1737-16. Denver, CO: U.S. Department of the Interior, Bureau of Land Management. 110 p.

Richardson, C.J. 2003. Pocosins: hydrologically isolated or integrated wetlands on the landscape? *Wetlands*. 23: 563–576.

Sada, D.W. 2001. Demography and habitat use of the Badwater snail (*Assiminea infima*), with observations on its conservation status. *Hydrobiologia*. 466: 255–265.

Sada, D. W.; Pohlmann, K.F. 2006 (draft). U.S. National Park Service Mojave inventory and monitoring network spring survey protocols: level I and level II. Reno and Las Vegas, NV: Desert Research Institute. 95 p.

Schoeneberger, P.J.; Wysocki, D.A.; Benham, E.C.; Broderson, W.D. 2002. Field book for describing and sampling soils, version 2.0. Lincoln, NE: U.S. Department of Agriculture, Natural Resources Conservation Service, National Soil Survey Center. 228 p.

Sharitz, R.R. 2003. Carolina Bay wetlands: unique habitats of the Southeastern United States. *Wetlands*. 23: 550–562.

Springer, A.E.; Stevens, L.E. 2009. Spheres of discharge of springs. *Hydrogeology Journal*. 17(1): 83–94.

Stevens, L.; Kloeppel, H.; Springer, A.; Sada, D. 2006. Terrestrial springs ecosystems inventory protocols narrative. NPS Cooperative Agreement Number CA 1200-99-009, TASK# NAU-118. Flagstaff, AZ: National Park Service. 45 p.

Stevens, L.E.; Meretsky, V.J. 2008. Springs ecosystem ecology and conservation. In: Stevens, L.E.; Meretsky, V.J. eds. *Aridland springs in North America: ecology and conservation*. Tucson, AZ: University of Arizona Press: 3–10.

Stevens, L.E.; Springer, A.E. In development. Springs ecosystem assessment protocol scoring criteria. Flagstaff, AZ: Springs Stewardship Institute. <http://springstewardship.org/assessment.html>. (14 October 2011).

U.S. Army Corps of Engineers. 1987. Corps of Engineers wetlands delineation manual. Vicksburg, MS: U.S. Army Corps of Engineers, Waterways Experiment Station. 143 p.

U.S. Department of Agriculture (USDA), Forest Service. 2009. Site general: field guide. Washington, DC: U.S. Department of Agriculture, Forest Service, Rangeland Management Staff. 57 p.

USDA Natural Resources Conservation Service (NRCS). 2010. Keys to soil taxonomy. Washington, DC: U.S. Department of Agriculture, Natural Resources Conservation Service. 346 p.

USDA NRCS. 2006. Field indicators of hydric soils in the United States, Version 6.0. In: Hurt, G.W.; Vasilas, L.M., eds. U.S. Department of Agriculture, Natural Resources Conservation Service, in cooperation with the National Technical Committee for Hydric Soils. 47 p.

U.S. Environmental Protection Agency (EPA). 2008. Methods for evaluating wetland condition: biogeochemical indicators. EPA-822-R-08-022. Washington, DC: U.S. Environmental Protection Agency, Office of Water. 44 p.

U.S. Fish and Wildlife Service (USFWS). 1988. National list of vascular plant species that occur in wetlands. U.S. Fish and Wildlife Service Biological Report 88(26.9). <http://plants.usda.gov/wetinfo.html>. (16 June 2011).

USFWS. 1999. Peatland mitigation policy considerations. Lakewood, CO: U.S. Fish and Wildlife Service, Region 6: 35. 39 p.

U.S. Geological Survey. (variously dated 1997 to 2011). National field manual for the collection of water-quality data: U.S. Geological Survey Techniques of water-resources investigations, book 9, chaps. A1–A9. <http://water.usgs.gov/owq/FieldManual/>. (15 November 2011).

Voshell, J.R., 2002. A guide to common freshwater invertebrates of North America. Blacksburg, VA: McDonald and Woodward Publishing Co. 442 p.

Weixelman, D.A.; Cooper, D.J. 2009. Assessing proper functioning condition for fen areas in the Sierra Nevada and Southern Cascade Ranges in California: a user guide. Gen. Tech. Rep. R5-TP-028. Vallejo, CA: U.S. Department of Agriculture, Forest Service, Pacific Southwest Region. 52 p.

Winthers, E.; Fallon, D.; Haglund J.; et. al. 2005. Terrestrial ecological unit inventory technical guide. Washington, DC: U.S. Department of Agriculture, Forest Service, Washington Office, Ecosystem Management Coordination Staff. 245 p.

Appendix 1. Order of Data Collection

The methods are generally presented in the recommended order that they should be conducted on the site. The order presented here is partially intended to minimize the amount of walking on the Groundwater Dependent Ecosystems site and the number of trips into or across the site to avoid trampling the soil and vegetation.

Recommended order of collecting field data

1. Wildlife (mammals, birds, etc.) observations upon arrival at site.
2. Water quality—surface water (if done).
3. Aquatic macroinvertebrates.
4. Location and geologic information (Universal Transverse Mercators, elevation, etc.).
5. Vegetation.
6. Soils: soil core and data collection.
7. Hydrology.
 - i. Water quality—subsurface water (use borehole from soil core or augered hole for water table).
 - ii. Water quantity.
 - a. Water table depth.
 - b. Flow.
 - c. Spring brook measures (if applicable).
8. Aquatic and Terrestrial Fauna (macroinvertebrates are done earlier).
9. Photos.
10. Sketch map of site.
11. Natural and anthropogenic disturbances.
12. Management indicator tool.

Appendix 2. Job Hazard Analysis

<p>U.S. Dept. of Agriculture Forest Service JOB HAZARD ANALYSIS (JHA) References-FSH 6709.11 and-12 (Instructions on reverse)</p>	<p>1. WORK PROJECT/ACTIVITY Field Data Collection</p> <p>4. NAME OF ANALYST</p>	<p>2. LOCATION</p> <p>5. JOB TITLE</p>	<p>3. UNIT</p> <p>6. DATE PREPARED January 2010</p>
<p>7. TASK/PROCEDURES</p> <p>1. Driving from either official or temporary duty station to field location</p>	<p>8. HAZARDS</p> <p>a. Hazardous road conditions during some portions of the year</p> <p>b. Driving in off-road situations with or without four-wheel drive</p> <p>c. Vehicle breakdown and unable to get to shelter</p> <p>d. Cell phones</p> <p>e. Female traveling alone</p>	<p>9. ABATEMENT ACTIONS</p> <ul style="list-style-type: none"> • Drive with extreme caution. • All field personnel attend defensive driving class renewed at least every three portions of the year. • See "Winter Travel" and "General Driving" JHA. • All new personnel receive training on the use and operation of four-wheel drive vehicles. • Drive with extreme caution. • Ensure that each vehicle is equipped with a seasonal survival kit that has been inspected and includes all items that are necessary. • Absolutely no using cell phones while driving a Government vehicle. This includes texting and talking. • Avoid hotel rooms on the ground floor. Do not accept a room with adjoining door entry. Keep cell phone handy and fully charged. Wear a wedding ring. Park in well lit areas. 	
<p>2. Foot travel</p>	<p>a. Slips, trips, and falls</p> <p>b. Allergic reaction to insect bites (e.g., bee stings)</p>	<ul style="list-style-type: none"> • Wear nonskid boots that are appropriate for conditions. • Watch where walking. • Stay on trails when able. • Use a walking stick when necessary. 	<ul style="list-style-type: none"> • Ensure that all personnel with known allergic reactions to insect bites carry appropriate medication. In addition, the allergic individuals should make sure that their partner knows where the medication is kept and can administer it in an emergency situation.

	<ul style="list-style-type: none"> • In case of a bite or sting, watch subject closely for any allergic reaction. Call 911 or local emergency number and evacuate immediately if any reaction away from injury site is observed.
c. Branches striking eyes	<ul style="list-style-type: none"> • Keep a safe distance from partner. • Wear protective eyewear.
d. Crossing shallow streams	<ul style="list-style-type: none"> • Always work with a partner when planning stream or river crossings with water depths over the knees. Choose crossing sites with shallow water, slow currents, and gradual slopes. Avoid crossing sites with water over mid-thigh depths or swift current. • Use pole or walking stick to help maintain balance with three-point support. Move one foot or pole at a time. • Watch for and avoid large, wet, rounded rocks because they may be slippery. • Be especially alert to the possibility of one foot becoming entrapped in rocks or branches and current forcing individual off balance and under water. • Carry a rope or throw rope long enough to reach across the entire width of the crossing. • Make the crossing one person at a time with one person on the bank at all times. Stretch the safety rope between the person on the bank and the person crossing. • Logs should be used as last alternative and should be of sufficient size, dry, and algae free. • Leave vest unbuttoned, remove workbelt from waist, disconnect waist and sternum straps on pack, and be prepared to ditch any equipment if you are unable to recover from a fall. • Protect feet with proper footwear such as waders. Bring dry socks and footwear to wear during field work and hiking. • Do not cross streams during unfavorable weather.

3. Use of snowmobile to travel to the field location		<ul style="list-style-type: none"> • See "Snowmobile Use" JHA.
4. Use of boat to travel to the field location		<ul style="list-style-type: none"> • See "Boat Travel" JHA.
5. Use of all-terrain vehicle to travel to the field location		<ul style="list-style-type: none"> • See "ATV Travel" JHA.
6. Driving FS/GSA vehicles		<ul style="list-style-type: none"> • See "General Driving and 15 Passenger Vans" JHA.
7. Overnight travel		<ul style="list-style-type: none"> • See "Overnight Travel" JHA.
8. Office work		<ul style="list-style-type: none"> • See "Office Work" JHA.
9. Conducting field work	a. Use of hand tools such as hand axe, pruning saw, and shovel	<ul style="list-style-type: none"> • When traversing slopes, carry hand tools on the downhill side. • Hand axes should always be carried sheathed with leather flap snapped shut. • Do not carry long handled tools over shoulder, or hatchets unsheathed in belt-loop.
	b. Dehydration	<ul style="list-style-type: none"> • Consume (in addition to regular meals) fruit and liquids that replace the loss of carbohydrates and maintain blood sugar levels at normal limits. Drink water regularly. Make sure you carry enough water. Take frequent breaks. Avoid open sunny areas if weather is extreme. Seek shaded areas.
	c. Hypothermia	<ul style="list-style-type: none"> • Prevent hypothermia by planning ahead and using your gear to stay warm and dry. • On cool days be aware of overheating and then rapidly cooling down. • Dress appropriately and in layers to account for temperature extremes. • Stay hydrated and eat high-energy foods. • See "Winter Travel" JHA for more detailed information.

d. Poisonous plants present (e.g., poison ivy)	<ul style="list-style-type: none"> • Make sure that crew members can identify poisonous plants in their work area. • Wear gloves and long-sleeve shirts. • Wash affected area with soap and water as soon as possible or use ivy-off products when water is not available. • Wash potentially contaminated clothing as soon as possible after returning from the field.
e. Falling branch or tree	<ul style="list-style-type: none"> • Wear hardhat. • Use extra caution during high-wind events.
f. Insect bites	<ul style="list-style-type: none"> • Use appropriate insect repellent. • Secure bottom of pant legs to reduce the ability for ticks to access your lower leg. • Thoroughly examine your body for ticks when returning from field. If a tick is found, fully remove it using tweezers or fingernails. Do not use petroleum or try to burn the tick off. Save the tick for confirmation of Lyme disease. Monitor the area on body where tick was attached, watching for irritation or rash. If rash or flu-like symptoms develop, visit a doctor and inform him or her of tick bite.
g. Sun exposure	<ul style="list-style-type: none"> • Use sun screen on exposed skin to prevent sunburn and skin damage. Know the signs and symptoms of heat exhaustion and heat stroke. Wear sunglasses and use sunscreen. Drink enough water to keep hydrated.
h. Altitude problems	<ul style="list-style-type: none"> • Headache, shortness of breath, trouble sleeping, and dizziness. Drink more water than usual and reduce salty food intake.
i. Waders and wading boots	<ul style="list-style-type: none"> • Only wear waders that are the correct size for your feet and body. Nylon breathable waders are adaptable to a wide variety of temperatures and conditions, and they are essential. Supportive wading boots are essential and give the traction and support necessary for stream work. Wading boots will be worn any time biological technicians are in streams.

10. Encountering hazardous situations	<p>a. Threatening individuals</p>	<ul style="list-style-type: none"> • Use positive communication and conflict management behaviors in early stages of conflict situations to prevent or diffuse low-level hostile behavior. • If threatened in any way by members of the public, withdraw and report the incident to your supervisor. • Always attain the landowner's permission before entering private property.
	<p>b. Illegal activities</p>	<ul style="list-style-type: none"> • Leave the area immediately if you feel unsafe because of illegal activity. • If an area appears to be used for illegal activities, such as a marijuana garden or methamphetamine lab, leave the area immediately by the same route taken to enter the area. • Report suspicious activity to your supervisor. • Always attain the landowner's permission before entering private property.
	<p>c. Wild animals such as black bears, wolves, bison, elk, deer, moose, bobcats, poisonous snakes, feral swine, etc.</p>	<ul style="list-style-type: none"> • Make noise by talking loudly or using a noisemaker such as a bell or whistle to reduce the chances of surprising an animal. • Immediately leave the area by backtracking if you encounter any animal that appears injured or sick, or may be feeding, mating, or have young nearby. Report the incident to the proper authorities if the animal acted aggressively without provocation. • Learn the appropriate actions to take if you are approached by any of the animals that may inhabit your work location. These actions differ depending on the type of animal. • Learn to identify dangerous animals in your working area and never harass or provoke wildlife. • Avoid walking blindly through thick vegetation by using a stick or pole in front of you to part the brush or grass. • In areas with poisonous snakes, tap the ground in front of you with a pole or stick as you walk to help you see snakes before you get too close. • Wear snake-proof chaps when appropriate.

d. Domestic animals such as dogs, cattle, swine, etc.	<ul style="list-style-type: none"> • If an animal is acting aggressive or skittish, stay in the vehicle and wait for the landowner to come outside. Honk your horn if necessary to alert the landowner that you are there. • Ask landowners over the phone about the location of potentially dangerous domestic animals and request that they be moved or tied up while you are visiting the location, or plan to visit when the animal will not be there. • Make sure that landowners know when you are working in the area if you believe they may have an aggressive or protective animal.
e. Hazardous materials	<ul style="list-style-type: none"> • Whenever encountering containers of unidentified liquids or powders, stay clear of the site. Do not walk into or touch spilled material. Avoid inhalation of fumes, smoke, and vapors, even if no hazardous materials are known to be involved. Do not assume that gases or vapors are harmless because they do not smell. Odorless gases or vapors may be harmful. Drums may contain toxic materials, leak, and contaminate their immediate surroundings. • If it is possible to read any labels without risk of contaminating yourself, do so and write the information down. Note location, time of encounter, and any other pertinent information. Then report it to supervisor. • Likely areas where hazardous materials are encountered include abandoned mine sites, old construction sites, and old homestead sites.
f. Encountering hunters	<ul style="list-style-type: none"> • Plan field work appropriately given area hunting use and seasons. • Wear blaze orange vest or clothing. • Ensure landowners know where you will be and when you will be there. • Inform hunters of where you will be and how long you expect to be there, and find out where they plan to hunt. • If someone is hunting near your plot and is there first, return at a later date.
10. LINE OFFICER SIGNATURE	11. TITLE
	12. DATE

JHA Instructions (References-FSH 6709.11 and .12)

The JHA shall identify the location of the work project or activity, the name of employee(s) involved in the process, the date(s) of acknowledgment, and the name of the appropriate line officer approving the JHA. The line officer acknowledges that employees have read and understand the contents, have received the required training, and are qualified to perform the work project or activity.

Blocks 1, 2, 3, 4, 5, and 6: Self-explanatory.

Block 7: Identify all tasks and procedures associated with the work project or activity that have potential to cause injury or illness to personnel and damage to property or material. Include emergency evacuation procedures (EEP).

Block 8: Identify all known or suspect hazards associated with each respective task/procedure listed in block 7. For example—

- a. Research past accidents/incidents.
- b. Research the Health and Safety Code, FSH 6709.11, or other appropriate literature.
- c. Discuss the work project/activity with participants.
- d. Observe the work project/activity.
- e. A combination of the above.

Block 9: Identify appropriate actions to reduce or eliminate the hazards identified in block 8. Abatement measures listed below are in the order of the preferred abatement method:

- a. Engineering controls (the most desirable method of abatement). For example, ergonomically designed tools, equipment, and furniture.
- b. Substitution. For example, switching to high flashpoint, nontoxic solvents.
- c. Administrative controls. For example, limiting exposure by reducing the work schedule and establishing appropriate procedures and practices.
- d. Personal protective equipment (PPE) (least desirable method of abatement). For example, using hearing protection when working with or close to portable machines (chain saws, rock drills, and portable water pumps).
- e. A combination of the above.

Block 10: The JHA must be reviewed and approved by a line officer. Attach a copy of the JHA as justification for purchase orders when procuring PPE.

Blocks 11 and 12: Self-explanatory.

EEP Instructions (Reference FSH 6709.11)

Work supervisors and crew members are responsible for developing and discussing field EEP and alternatives in the event a person becomes seriously ill or injured at the worksite.

Be prepared to provide the following information:

- a. Nature of the accident or injury (avoid using victim’s name).
- b. Type of assistance needed, if any (ground, air, or water evacuation).
- c. Location of accident or injury, best access route into the worksite (road name or number), identifiable ground and air landmarks.
- d. Radio frequencies.
- e. Contact person.
- f. Local hazards to ground or aviation vehicles.
- g. Weather conditions (wind speed and direction, visibility, and temperature).
- h. Topography.
- i. Number of individuals to be transported.
- j. Estimated weight of individuals for air or water evacuation.

The items listed above serve only as guidelines for the development of EEPs.

JHA and Emergency Evacuation Procedures Acknowledgment

We, the undersigned work leader and crew members, acknowledge participation in the development of this JHA (as applicable) and accompanying EEPs. We have thoroughly discussed and understand the provisions of each of these documents:

SIGNATURE	DATE	SIGNATURE	DATE
_____	_____	_____	_____
_____	_____	_____	_____
_____	_____	_____	_____
_____	_____	_____	_____

Appendix 3. Field Forms

List of Acronyms

GDE = Groundwater-dependent ecosystems

FS = Forest Service

ID = Identification

LOV in FG = List of values in field guide

NRM-Infra = Natural Resource Manager-Infrastructure

HUC = hydrologic unit code

USGS = U.S. Geological Survey

LRR = Land Resource Region

MLRA = Major Land Resource Area

UTM = Universal Transverse Mercator

UOM = Unit of measure

F = Fahrenheit

C = Celsius

GPS = Global Positioning System

NAD = North American Datum

WGS = World Geodetic System

HCL = hydrochloric acid

mv = millivolts

mg/L = milligrams per liter

(μ S/cm) = microsiemens/centimeter

ORP = Oxidation-reduction potential

DO = dissolved oxygen

ATV = All-terrain vehicle

SOI = Species of interest

TES = Threatened and endangered species

SOC = Species of concern

	Forest Service GDE Level I Inventory	Site Name _____
		Recorder _____
		Page ____ of ____
	Pre-Field Survey <i>(this site information is compiled prior to field visit and updated in the field as necessary)</i>	
Site and Geographic (p. 23)	Site ID _____ Project Name _____	
	Purpose(s) (LOV in FG) _____ State(s) _____	
	County(s) _____ Land Status(s) _____ FS Region(s) _____	
	FS Forest/Grassland/Prairie(s) _____ FS District(s) _____	
	Grazing Allotment Number _____ Grazing Allotment Name _____	
	NRM-Infra Reference Number _____	
	Water Right Number _____ Water Right Status _____	
	HUC(s)(12-digits) _____ Ecological Unit _____	
	Ecological System (LOV in FG appendix) _____	
	Local Feature-Type Name _____	
.....		
Mapping (p. 29)	USGS Quad _____ Magnetic Declination _____	
	Geologic Map Name _____ Geologic Map Unit _____	
	Land Resource Region (LRR) and MLRA _____	
	Soil Map Name _____ Soil Map Unit _____	
.....		
Route (p. 31)	<i>Information to help arrive at site, which will also be recorded in the field (on Field Survey Activities form)</i>	
	UTM coordinates: Zone _____ Easting _____ Northing _____	
	Latitude Degrees _____ Minutes _____ Seconds _____	
	Longitude Degrees _____ Minutes _____ Seconds _____	
	Latitude Decimal Degree _____ Longitude Decimal Degree _____	
	Horizontal Datum _____ Elevation _____ UOM _____	
	
	Location—Driving route _____	

	Location—Hiking route _____	

Location—Other _____		
.....		
Other (p. 32)	Preliminary GDE Type(s) _____	
	Determination Source _____	
	Archeological, Paleontological, Cultural, or Historic Sites or Use _____	
	Available Data (other sources) _____	

Forest Service GDE Level I Inventory

Site Name _____

Recorder _____

Page ____ of ____

Field Survey Activities

Site ID _____

Survey Date _____ Time Start _____ End _____

Examiners _____

Air Temp (UOM: F or C) _____

Area of GDE (and UOM) _____

Area Determined by (LOV in FG) _____

Reference Point (briefly describe) _____

Slope (%) _____

Aspect (degrees) _____

Weather (select 1)

- Recent rain
- Rain during survey
- Snowfall, hail, sleet during survey
- Snow on ground
- No current/recent precipitation

Relative Area of GDE

- ____ % Spring emergence
- ____ % Channel
- ____ % Wetland/Riparian
- ____ % Open water
- ____ % Other or unknown

Survey Information (p. 35)

Horizontal Datum (select 1)

- NAD-27
- NAD-83 (recommended)
- WGS-72
- WGS-84

GPS Make & Model _____ GPS Accuracy _____

UTM Zone _____ Easting _____ Northing _____

Latitude Degrees _____ Minutes _____ Seconds _____

Longitude Degrees _____ Minutes _____ Seconds _____

Latitude Decimal Degree _____ Longitude Decimal Degree _____

Elevation _____ UOM _____ Determined by (circle 1) GPS; Topo Map; Other _____

Georeferencing (p. 40)

Evidence of Groundwater (LOV in FG) _____

Geologic Structure Type (select 1)

- Bedding
 - Contact
 - Fault
 - Fracture
 - Lincation
 - Conduit
 - Unknown
- Determined by
- Observation
 - Geologic Map
 - Other:

GDE Type, primary _____

GDE Type, secondary(s) _____

Surficial Material, primary (LOV in FG) _____

Surficial Material, secondary(s) (LOV in FG) _____

Lithology, primary (LOV in FG) _____

Is primary lithology also groundwater source aquifer (circle 1): Yes No Unknown

Level of certainty (circle 1): Known Assumed Unknown

Lithology, secondary (LOV in FG appendix) _____

Landform, primary (LOV in FG appendix) _____

Landform, secondary (LOV in FG appendix) _____

Geologic Setting (p. 43)

Geology Notes _____

Forest Service GDE Level I Inventory

Site Name _____

Recorder _____

Page ____ of ____

Site Sketch Map (p. 50)

To include on map:

- | | |
|--|--|
| <input type="checkbox"/> Reference point | <input type="checkbox"/> Location of measurements: |
| <input type="checkbox"/> Approximate locations/dimensions of major geomorphic surfaces | <input type="checkbox"/> Soil hole(s) |
| <input type="checkbox"/> Springs: | <input type="checkbox"/> Water table measurement location(s) |
| <input type="checkbox"/> Spring source | <input type="checkbox"/> Wells/piezometers |
| <input type="checkbox"/> Channel locations | <input type="checkbox"/> Water quality sample(s) |
| <input type="checkbox"/> Structures including spring boxes, troughs, and pipelines | <input type="checkbox"/> Structures or other human-made features |
| <input type="checkbox"/> Pool location, if limnocrene | <input type="checkbox"/> Indication of North (true recommended, or magnetic) |
| <input type="checkbox"/> Areas of standing water (indicate deepest part) | <input type="checkbox"/> Indication of scale |
| | <input type="checkbox"/> Boundaries of GDE |

Site Name _____
 Recorder _____
 Page _____ of _____

Forest Service GDE Level I Inventory

Soil (p. 55)

Method of soil extraction _____

Location	Depth of Peat, Mucky Peat, and Muck (such as 8 cm to 17 cm) (and UOM)	Depth to Mineral Layer (and UOM)	Texture of Mineral Layer	Color of Mineral Soil	Redoximorphic Features and Depths (and UOM)	Hydrogen Sulfide Odor	Reaction to Dilute HCl	Depth of Hole (and UOM)	Comments

Fen Characteristics (p. 60)

Yes, fen characteristics observed or No, fen characteristics not observed Comments _____
 Yes, histosol or histic epipedon observed or No, histosol or histic epipedon not observed Comments _____

Forest Service GDE Level I Inventory

Site Name _____

Recorder _____

Page ____ of ____

Hydrology

Water Table (p. 64)

Location	Source of Water Table Measurement	Hole Depth (and UOM)	Water Table Depth (and UOM)	Dry (yes or no)

Water Table Type (select 1)

- Apparent
- Artesian
- Ponding
- Unknown
- Other: _____

Flow Patterns for Site

Inflow (select 1; LOV in FG): _____

Outflow (select 1; LOV in FG): _____

Surface Water (multiple ok)

- No standing or flowing water visible
- Patches of standing water
- Extensive standing water
- Flowing water in channels

Flow and Spring Channel (p. 67)

Location of Flow Measurement	Flow Method	Flow Instrument	Flow (and UOM)	Percent Captured	Comments

Site Flow Estimate: _____ Comment: _____

Reason if no flow measurement (circle 1): Diffuse flow; No outflow; Not a spring; Spring is dry; Other _____

Hydroperiod (LOV in FG) _____ Length of Outflow Stream (LOV in FG) _____

What Happens to Stream Outflow (LOV in FG) _____

Water Quality (p. 71)

Location	Time of Day	Temperature (UOM: F or C)	Water pH	Specific Conductance ($\mu\text{S}/\text{cm}$)	ORP (mV)	DO (mg/L)

Forest Service GDE Level I Inventory

Site Name _____

Recorder _____

Page ____ of ____

Disturbance (p. 77)

Hydrologic Alteration (multiple ok)

- Water diversion (permanently diverted)
- Water diversion (water eventually returns to site)
- Upgradient extraction of surface water or groundwater (prespring emergence)
- Downgradient capture of surface water or groundwater (post-spring emergence)
- Extraction of water within a wetland
- Extraction of water at spring source
- Regulated water flow by impoundment/dam
- Pollution
- Flooding
- Wells
- None observed
- Other: _____

Diverted Volume _____ UOM _____

Percent Diverted _____

Soil Alteration (multiple ok)

- Channel erosion
- Compaction
- Debris flow
- Deposition
- Displacement of soil
- Erosion (general)
- Evaporate deposition
- Excavation
- Ground disturbance (general)
- Gully erosion
- Mass wasting
- Mining
- Pedestals or hummocks (by people or animals)
- Pedestals (small-scale, rain-splash induced)
- Pipes
- Rill erosion
- Ruts (from vehicle tread)
- Sheet erosion
- Slump
- Splash erosion/ soil crust
- Wind erosion
- Soil mixing/churning
- Soil removal (peat mining)
- Trails (by people or animals)
- None observed
- Other: _____

Structures (multiple ok)

- Buried utility corridors
- Enclosure (such as spring house, spring box or concrete enclosure)
- Erosion control structure
- Exclosure fence
- Oil and gas well
- Pipeline
- Point source pollution
- Power lines
- Road (includes construction and maintenance)
- None observed
- Other: _____

Recreational Effects (multiple ok)

- Camp sites
- Tracks or trails by vehicles (ATV, 4-wheel drive, etc.)
- None observed
- Other: _____

Animal Effects (multiple ok)

- Beaver activity
- Feral animals
- Grazing or browsing (by ungulates)
- Wild animals
- Livestock
- Trails by animals and people
- Trampling (by ungulates, native or nonnative)
- None observed
- Other: _____

Miscellaneous (multiple ok)

- Fire
- Tree cutting (timber harvest or other)
- Refuse disposal
- None observed
- Other: _____

Archeological, Paleontological, Cultural, Historic Sites/Use

Forest Service GDE Level I Inventory

Site Name _____

Recorder _____

Page ____ of ____

Management Indicator Tool (p. 82)

Management Indicators	True (Yes)	False (No)	Does Not Apply	Unable To Assess	Comment
Hydrology					
1. <i>Aquifer Functionality</i> : No evidence suggests that the aquifer supplying groundwater to the site is being affected by groundwater withdrawal or loss of recharge.					
2. <i>Watershed Functionality</i> : Within the watershed, no evidence suggests upstream/upgradient hydrologic alteration that could adversely affect the GDE site.					
3. <i>Water Quality</i> : Changes in water quality (surface or subsurface) are not affecting the groundwater dependent ecosystem site.					
Geomorphology and Soils					
4. <i>Landform Stability</i> : No evidence indicates human-caused mass movement or other surface disturbance affecting the GDE site stability.					
5. <i>Ranout Channel</i> : The channel, if present, is functioning naturally and is not entrenched, eroded, or otherwise substantially altered.					
6. <i>Soil Integrity</i> : Soils are intact and functional. For example, saturation is sufficient to maintain hydric soils, if present; there is not excessive erosion or deposition.					
Biology					
7. <i>Vegetation Composition</i> : The site includes anticipated cover of plant species associated with the site environment, and no evidence suggests that upland species are replacing hydric species.					
8. <i>Vegetation Condition</i> : Vegetation exhibits seasonally appropriate health and vigor.					
9. <i>TES, SOI/SOC, Focal Floral Species</i> : Anticipated floral species are present (will vary by ecological region and will require some baseline information).					
10. <i>Faunal Species</i> : Anticipated aquatic and terrestrial faunal species associated with the site environment are present.					
11. <i>TES, SOI/SOC, Focal Faunal Species</i> : Anticipated faunal species are present (will vary by ecological region and will require some baseline information).					
12. <i>Invasive Species</i> : Invasive floral and faunal species are not established at the site.					

Forest Service GDE Level I Inventory

Management Indicators	True (Yes)	False (No)	Does Not Apply	Unable To Assess	Comment
Disturbances					
13. <i>Flow Regulation</i> : Flow regulation is not adversely affecting the site.					
14. <i>Construction and Road Effects</i> : Construction, reconstruction, or maintenance of physical improvements, including roads, is not adversely affecting the site.					
15. <i>Fencing Effects</i> : Protection fencing and exclosures are appropriate and functional.					
16. <i>Herbivore Effects</i> : Herbivory is not adversely affecting the site.					
17. <i>Recreational Effects</i> : Recreational uses, including trails, are not adversely affecting the site.					
18. <i>Other Disturbance Effects</i> : Wildland fire, insect, disease, wind throw, avalanches, or other disturbances are not adversely affecting the site.					
Administrative Context					
19. <i>Cultural Values</i> : Archaeological, historical, or tribal values will not affect inventory, restoration, use, or management of this site.					
20. <i>Land Ownership</i> : The entire site and immediate area is under the jurisdiction and management of the Forest Service.					
21. <i>Other Landowner Actions</i> : Activities or management on lands outside Forest Service jurisdiction are not adversely affecting the site.					
22. <i>Land Management Plan</i> : The land and resource management Plan provides for effective site protection.					
23. <i>Environmental Compliance</i> : Authorized and administrative uses are in compliance and are not adversely affecting the site.					
24. <i>Water Uses</i> : There are no substantial water uses in the watershed, or in the aquifer supplying groundwater to the site, that could directly or cumulatively adversely affect the GDE.					
25. <i>Water Rights</i> : Water rights have been filed for the site under State law or water uses exempted under State law are documented. Forest Service Federal reserved rights are documented as appropriate. Third-party water use is in accordance with all elements of the water right or conditions of the exemption, and with the Forest Service authorization that allows the use.					

Appendix 4. Site Protection Guidelines

This section is provided to help minimize the disturbance from the data-collection process by researchers, managers, and data collectors. The potential disturbances that can result from the data-collection process include the following:

- Trailing, erosion, geomorphic alteration (from foot traffic, etc.).
- Destruction or alteration of vegetation.
- Damage to peat.
- Soil compaction and altered soil-water storage.
- Hydrologic alteration from water measurement activities (wells, etc.).
- Spread of invasive species (by data collectors or managers).

To prevent damage to sites, please follow these guidelines:

Minimize

- Number of people who visit the site.
- Duration of visits.
- Frequency of visits.
- Walking on site.
- Digging holes.
- Destructive sampling.
- Collecting plant or animal specimens.
- Bringing heavy equipment to site.
- Placing heavy gear on wet areas.
- Using unsterilized equipment (nets, etc.).

Pre-Site Visit

- Decontaminate shoes/boots and equipment that will be brought to site to prevent importing invasive species or disease.
- Plan the visit to use the time wisely and to minimize the amount of walking on the site.

During the Site Visit

- Set equipment, especially heavy items, outside wet areas (in uplands).
- Consider taking pictures, or recording observations, instead of collecting specimens.
- Sit, eat lunch, etc., outside the wet area.
- Walk around the groundwater-dependent ecosystem site, rather than through it, as much as possible.
- Do multiple things on each trip through the site to minimize trampling.
- Place temporary wood planks on walking paths to avoid creating ruts that redirect and channelize water.

Post-Site Visit–Decontamination

At the end of each site visit, to prevent the spread of invasive species, decontaminate shoes/boots, waders, and all equipment used at the site. If you do not know if the decontamination was done after the last visit, then follow these procedures before a field visit.

1. Use a scrub brush (tooth brush for small equipment) and water to remove all visible mud, vegetation, and other material.
2. Dry the boots and equipment.
3. Soak boots in a Clorox solution or some other solution (such as Sparquat or 409) depending on the regional invasive species of concern.
4. Rinse with water (distilled for equipment).
5. Allow boots and equipment to air dry (in the sun works best).

Appendix 5. Groundwater-Dependent Ecological Systems Described in NatureServe

The following table lists Ecological Systems from NatureServe (2011) that exhibit groundwater dependency and the States where they are known to occur or where they potentially could occur (indicated by "?").

Ecological system	States
Fen systems	
Boreal-Laurentian-Acadian Acidic Basin Fen	MA, ME, MI, MN, NH, NY, VT, WI
Ozark-Ouachita Fen	AR, MO
North-Central Interior Shrub-Graminoid Alkaline Fen	IA, IL, IN, MI, MN, ND, OH, PA, SD, WI
Interior Low Plateau Seepage Fen	KY, OH?, TN
Southern and Central Appalachian Bog and Fen	GA, KY, NC, SC, TN, VA
Mediterranean California Serpentine Fen	CA, OR
North-Central Appalachian Seepage Fen	CT, MA, MD, NJ, NY, PA, VA, VT, WV
North Pacific Bog and Fen	AK, OR, WA
Mediterranean California Subalpine-Montane Fen	CA, NV, OR
Rocky Mountain Subalpine-Montane Fen	AZ, CO, ID, MT, NV, OR, UT, WA, WY
Laurentian-Acadian Alkaline Fen	MA, ME, MI, MN, NH, NY, PA, VT, WI
West Gulf Coastal Plain Herbaceous Seepage Bog	AR?, LA, TX
Southern Coastal Plain Herbaceous Seep and Bog	AL, FL, LA, MS
East Gulf Coastal Plain Interior Shrub Bog	AL, GA, MS
North-Central Interior and Appalachian Acidic Peatland	CT, IL, IN, MA, ME, MI, MN, NH, NJ, NY, OH, PA, RI, VT, WI
Southern Ridge and Valley Seepage Fen	AL, GA

Ecological system	States
Western North American Boreal Herbaceous Fen	AK
Alaskan Pacific Maritime Fen and Wet Meadow	AK
Western North American Boreal Black Spruce-Tamarack Fen	AK
Boreal-Laurentian Conifer Acidic Swamp and Treed Poor Fen	ME, MI, MN, NH, NY, VT, WI
Swamp systems	
Atlantic Coastal Plain Streamhead Seepage Swamp, Pocosin, and Baygall	FL, GA, NC, SC, VA
East Gulf Coastal Plain Northern Seepage Swamp	AL, IL, KY, MS, TN
Laurentian-Acadian Alkaline Conifer-Hardwood Swamp	CT, ME, MI, MN, NY, VT, WI
North Pacific Hardwood-Conifer Swamp	AK, OR, WA
North Pacific Shrub Swamp	AK, OR, WA
North-Central Appalachian Acidic Swamp	CT, MA, MD, NH, NJ, NY, OH, PA, RI, VA, VT
North-Central Interior Wet Meadow-Shrub Swamp	IA, IL, IN, MI, MN, MO, ND, OH, SD, WI
North-Central Interior and Appalachian Rich Swamp	CT, DE, IL, IN, MA, MD, MI, MN, NJ, NY, OH, PA, RI, VT, WI
Northern Appalachian-Acadian Conifer-Hardwood Acidic Swamp	CT, MA, ME, NH, NY, PA, VT
Northern Rocky Mountain Conifer Swamp	ID, MT, OR, WA, WY
Southern Coastal Plain Nonriverine Basin Swamp	AL, FL, GA, LA?, MS, SC
Southern Coastal Plain Seepage Swamp and Baygall	AL, FL, GA, LA, MS
West Gulf Coastal Plain Seepage Swamp and Baygall	AR, LA, OK, TX
Acadian-Appalachian Conifer Seepage Forest	ME, NH, NY, VT
Cumberland Seepage Forest	AL, KY, TN, WV

Ecological system	States
Central Atlantic Coastal Plain Nonriverine Swamp and Wet Hardwood Forest	GA, NC, SC, VA
Mediterranean California Serpentine Foothill and Lower Montane Riparian Woodland and Seep	CA, OR
Interior Highlands Forested Acidic Seep	AR, MO?, OK?
Central Florida Wet Prairie and Herbaceous Seep	FL
Atlantic Coastal Plain Sandhill Seep	GA, NC, SC
Piedmont Seepage Wetland	AL, GA, NC, SC, VA?
High Allegheny Wetland	MD, PA, WV
Southern Appalachian Seepage Wetland	GA, KY, NC, SC, TN, VA
Marsh systems	
North American Arid West Emergent Marsh	AZ, CA, CO, ID, MT, NM, NV, OR, TX, UT, WA, WY
Eastern Great Plains Wet Meadow, Prairie, and Marsh	IA, IL, KS, MN, MO, ND, NE, OK, SD, TX?
Northern Great Lakes Coastal Marsh	MI, WI
Temperate Pacific Freshwater Emergent Marsh	AK, CA, OR, WA
Western Great Plains Open Freshwater Depression Wetland	KS, MT, ND, NE, OK, SD, TX, WY
Other systems	
North Pacific Coastal Interdunal Wetland	AK, OR, WA
Mediterranean California Coastal Interdunal Wetland	CA, OR
Rocky Mountain Alpine-Montane Wet Meadow	AZ, CO, ID, MT, NM, NV, OR, SD, UT, WA, WY
Temperate Pacific Subalpine- Montane Wet Meadow	CA, NV, OR, WA
Colorado Plateau Hanging Garden	AZ, CO, NV?, UT
Southern Coastal Plain Spring-Run Stream Aquatic Vegetation	FL, GA

Appendix 6. Equipment List

- Field forms (appendix 3).
- Clipboard.
- Electronic data recorder (personal digital assistant, etc.), if available.
- Pencils.
- Notebook or paper (waterproof).
- Graph paper (for sketch map).
- Calculator.
- Topographic map of site.
- Aerial photograph of site.
- GPS (global positioning system) unit.
- Compass.
- Clinometer.
- Watch, stopwatch, or other timer.
- Photography.
 - Camera (digital is recommended, with extra memory and batteries).
 - Photo scale.
 - Board or card for identifying photo location.
- Water quality.
 - Temperature probe.
 - pH probe.
 - Oxidation-reduction potential (ORP) probe or dissolved oxygen (DO) probe.
 - Water conductivity probe.
 - Spare probes (temperature, pH, DO, ORP, and conductivity) and cable.

- Flow measurement (one or more of following).
 - Weir plate (and bubble level).
 - Current meter.
 - Flume (and bubble level).
 - Volumetric container(s).
 - Float (flagging, float device).
 - Current meter.
 - Wading rod.
 - Short pipe (for concentrating and measuring low flows).
- Soil/subsurface.
 - Shovel, spade, auger, and/or push probe with clean-out tool.
 - Soil knife/trowel.
 - Hand lens (10x or combination lenses).
 - pH kit.
 - Soil description sheets.
 - Water/spray bottle.
 - Soil color book (Munsell color chart with gley color plates).
 - Dilute hydrochloric acid (HCl) with dropper.
 - Local soil survey.
 - Bailing can—where groundwater can fill soil pits.
- Vegetation.
 - Plant press (with cardboard, newspaper, and felt).
 - Plant lists and identification resources for region.
 - Sample bags.
 - Digging tool (could be same as for soil sampling).

- Fauna.
 - Animal lists and identification resources for region.
 - Binoculars (for observing birds and other wildlife, or plants on cliff wall).
 - Aquatic macroinvertebrate and vertebrate sampling tools, as desired, such as hand net.
- Decontamination materials/supplies.

Appendix 7. Secondary Lithology

The secondary lithology list in the following table is based on USDA Forest Service (2009).

Secondary code	Primary lithology	Secondary lithology
ANBA	Igneous extrusive	Analcite basalt
ANDE	Igneous extrusive	Andesite
ANPO	Igneous extrusive	Andesite porphyry
BASA	Igneous extrusive	Basalt
BAPO	Igneous extrusive	Basalt porphyry
BAAN	Igneous extrusive	Basaltic andesite
BASN	Igneous extrusive	Basanite
DACI	Igneous extrusive	Dacite
DAPO	Igneous extrusive	Dacite porphyry
FELS	Igneous extrusive	Felsite
LATI	Igneous extrusive	Latite
LAPO	Igneous extrusive	Latite porphyry
LEBA	Igneous extrusive	Leucite dasanite
LEPH	Igneous extrusive	Leucite phonolite
LETE	Igneous extrusive	Leucite tephrite
LIMB	Igneous extrusive	Limburgite
LIPO	Igneous extrusive	Limburgite porphyry
MELI	Igneous extrusive	Mellitite
NELA	Igneous extrusive	Nepheline latite
NELAPO	Igneous extrusive	Nepheline latite porphyry
NEPH	Igneous extrusive	Nephelinite
OBSI	Igneous extrusive	Obsidian
OCEA	Igneous extrusive	Oceanite
OLBA	Igneous extrusive	Olivine basalt
OLNE	Igneous extrusive	Olivine nephelinite
PERL	Igneous extrusive	Perlite
PHON	Igneous extrusive	Phonolite
PHPO	Igneous extrusive	Phonolite porphyry
PITC	Igneous extrusive	Pitchstone
PUMI	Igneous extrusive	Pumice
QUBA	Igneous extrusive	Quartz basalt
QULA	Igneous extrusive	Quartz latite
QULAPO	Igneous extrusive	Quartz latite porphyry
RHYO	Igneous extrusive	Rhyolite

Secondary code	Primary lithology	Secondary lithology
RHPO	Igneous extrusive	Rhyolite porphyry
SCOR	Igneous extrusive	Scoria
TEPR	Igneous extrusive	Tephrite
TEPO	Igneous extrusive	Tephrite porphyry
TING	Igneous extrusive	Tinguaite
TRAC	Igneous extrusive	Trachyte
TRPO	Igneous extrusive	Trachyte porphyry
TRAP	Igneous extrusive	Trap
VITR	Igneous extrusive	Vitrophyre
WYOM	Igneous extrusive	Wyomingite
ALSK	Igneous intrusive	Alaskite
ALGR	Igneous intrusive	Alkali granite
ALSY	Igneous intrusive	Alkali syenite
ANOR	Igneous intrusive	Anorthosite
APLI	Igneous intrusive	Aplite
CHAR	Igneous intrusive	Charnockite
DIAB	Igneous intrusive	Diabase
DIOR	Igneous intrusive	Diorite
DIPO	Igneous intrusive	Diorite porphyry
DITR	Igneous intrusive	Ditroite
DUNI	Igneous intrusive	Dunite
FERG	Igneous intrusive	Fergusonite
FOYA	Igneous intrusive	Foyaite
GABB	Igneous intrusive	Gabbro
GAPO	Igneous intrusive	Gabbro porphyry
GADI	Igneous intrusive	Gabbro/diorite
GRAN	Igneous intrusive	Granite
GRPO	Igneous intrusive	Granite porphyry
GRAO	Igneous intrusive	Granodiorite
GDPO	Igneous intrusive	Granodiorite porphyry
GRGR	Igneous intrusive	Graphic granite
HARZ	Igneous intrusive	Harzburgite
LAMP	Igneous intrusive	Lamprophyre
LARV	Igneous intrusive	Larvikite
LESY	Igneous intrusive	Leucite syenite
LUXU	Igneous intrusive	Luxullianite
MALI	Igneous intrusive	Malignite
MISS	Igneous intrusive	Missourite

Secondary code	Primary lithology	Secondary lithology
MONZ	Igneous intrusive	Monzonite
MOPO	Igneous intrusive	Monzonite porphyry
NEMO	Igneous intrusive	Nepheline monzonite
NEMOPO	Igneous intrusive	Nepheline monzonite porphyry
NESY	Igneous intrusive	Nepheline syenite
NESYPO	Igneous intrusive	Nepheline syenite porphyry
NORD	Igneous intrusive	Nordmarkite
NORI	Igneous intrusive	Norite
OLGA	Igneous intrusive	Olivine gabbro
PEGM	Igneous intrusive	Pegmatite
PERI	Igneous intrusive	Peridotite
PICR	Igneous intrusive	Picrite
PULA	Igneous intrusive	Pulaskite
PYRO	Igneous intrusive	Pyroxenite
QUDI	Igneous intrusive	Quartz diorite
QUDIPO	Igneous intrusive	Quartz diorite porphyry
QUGA	Igneous intrusive	Quartz gabbro
QUMO	Igneous intrusive	Quartz monzonite
QUMOPO	Igneous intrusive	Quartz monzonite porphyry
QUSY	Igneous intrusive	Quartz syenite
SHON	Igneous intrusive	Shonikite
SOSY	Igneous intrusive	Sodalite syenite
SYEN	Igneous intrusive	Syenite
SYPO	Igneous intrusive	Syenite porphyry
SYEO	Igneous intrusive	Syenodiorite
THER	Igneous intrusive	Theralite
THPO	Igneous intrusive	Theralite porphyry
TROC	Igneous intrusive	Troctolite
UNCO	Igneous intrusive	Uncompahgrite
UOLI	Igneous intrusive	Uolite
ACHO	Metamorphic	Actinolite hornfels
ACMA	Metamorphic	Actinolite marble
ACSC	Metamorphic	Actinolite schist
ACEPMA	Metamorphic	Actinolite-epidote marble
ALMISC	Metamorphic	Albite-mica schist
AMPH	Metamorphic	Amphibolite
AMGN	Metamorphic	Amphibolite gneiss
ANHO	Metamorphic	Andalusite hornfels

Secondary code	Primary lithology	Secondary lithology
ANSC	Metamorphic	Andalusite schist
ANSPSL	Metamorphic	Andalusite spotted slate
ANBIHO	Metamorphic	Andalusite-biotite hornfels
ANGN	Metamorphic	Anorthosite gneiss
ATHO	Metamorphic	Anthophyllite hornfels
ARGN	Metamorphic	Arkose gneiss
AUGN	Metamorphic	Augen gneiss
BIGN	Metamorphic	Biotite gneiss
BISPSL	Metamorphic	Biotite spotted slate
BICLSC	Metamorphic	Biotite-chlorite schist
BLSL	Metamorphic	Black slate
BRMA	Metamorphic	Brucite marble
CAHO	Metamorphic	Calc-silicate hornfels
CLSL	Metamorphic	Calcareous slate
CASC	Metamorphic	Calcite schist
CASL	Metamorphic	Carbonaceous slate
CHSC	Metamorphic	Chialstolite schist
CHSPSL	Metamorphic	Chialstolite spotted sate
CLMA	Metamorphic	Chlorite marble
CLSC	Metamorphic	Chlorite schist
CDSC	Metamorphic	Chloritoid schist
CHMA	Metamorphic	Chondrodite marble
COGN	Metamorphic	Conglomerate gneiss
COHO	Metamorphic	Cordierite hornfels
COANHO	Metamorphic	Cordierite-anthophyllite hornfels
CRME	Metamorphic	Crystalline metamorphic
DBGN	Metamorphic	Diabase gneiss
DIMA	Metamorphic	Diopside marble
DIGN	Metamorphic	Diorite gneiss
ECLO	Metamorphic	Eclogite
EPAM	Metamorphic	Epidote amphibolite
EPGN	Metamorphic	Epidote gneiss
EPHO	Metamorphic	Epidote hornfels
EPCHSC	Metamorphic	Epidote-chlorite schist
FLCO	Metamorphic	Flaser conglomerate
FLDI	Metamorphic	Flaser diorite
FLGR	Metamorphic	Flaser granite
GBGN	Metamorphic	Gabbro gneiss
GABIGN	Metamorphic	Garnet biotite gneiss

Secondary code	Primary lithology	Secondary lithology
GAGN	Metamorphic	Garnet gneiss
GAHO	Metamorphic	Garnet hornfels
GACLSC	Metamorphic	Garnet-chlorite schist
GAPYAM	Metamorphic	Garnet-pyroxene amphibolite
GLSC	Metamorphic	Glaucophanite schist
GNEI	Metamorphic	Gneiss
GRGN	Metamorphic	Granite gneiss
GDGN	Metamorphic	Granodiorite gneiss
GRNO	Metamorphic	Granofels
GRNU	Metamorphic	Granulite
GRMA	Metamorphic	Graphite marble
GRSC	Metamorphic	Graphite schist
GWGN	Metamorphic	Graywacke gneiss
GRSL	Metamorphic	Green slate
GREN	Metamorphic	Greenschist
GREE	Metamorphic	Greenstone
HOBISC	Metamorphic	Hornblende-biotite schist
HORN	Metamorphic	Hornfels
KYHO	Metamorphic	Kyanite hornfels
KYSC	Metamorphic	Kyanite schist
MAGN	Metamorphic	Magnetite
MARB	Metamorphic	Marble
MEAR	Metamorphic	Meta-argillite
METC	Metamorphic	Metaconglomerate
METQ	Metamorphic	Metaquartzite
MEME	Metamorphic	Metasedimentary melange
METS	Metamorphic	Metasedimentary rocks
MSCA	Metamorphic	Metasedimentary alcaeous
MSNC	Metamorphic	Metasedimentary noncalcareous
METV	Metamorphic	Metavolvanic rocks
MISC	Metamorphic	Mica schist
MIGM	Metamorphic	Migmatite
MOGN	Metamorphic	Monzonite gneiss
MYLO	Metamorphic	Mylonite
OLMA	Metamorphic	Olivine marble
PEGN	Metamorphic	Peridotite gneiss
PHYL	Metamorphic	Phyllite
PHLN	Metamorphic	Phyllonite
PLGN	Metamorphic	Plagioclase gneiss

Secondary code	Primary lithology	Secondary lithology
PYSC	Metamorphic	Pyrophyllite schist
PRGN	Metamorphic	Pyroxene gneiss
PYHO	Metamorphic	Pyroxene hornfels
PRSC	Metamorphic	Pyroxene schist
QUDIGN	Metamorphic	Quartz diorite gneiss
QUPOGN	Metamorphic	Quartz porphyry gneiss
QUMISC	Metamorphic	Quartz-mica schist
QUSESC	Metamorphic	Quartz-sericite schist
QUAR	Metamorphic	Quartzite
QUGN	Metamorphic	Quartzite gneiss
RHGN	Metamorphic	Rhyolite gneiss
SAGN	Metamorphic	Sandstone gneiss
SCHI	Metamorphic	Schist
SCQU	Metamorphic	Schistose quartzite
SERP	Metamorphic	Serpentine
SEMA	Metamorphic	Serpentine marble
SEME	Metamorphic	Serpentine melange
SIGASC	Metamorphic	Sillimanite garnet schist
SIGN	Metamorphic	Sillimanite gneiss
SISC	Metamorphic	Sillimanite schist
SISL	Metamorphic	Silty slate
SKAR	Metamorphic	Skarn
SKGN	Metamorphic	Skarn gneiss
SLAT	Metamorphic	Slate
SOAP	Metamorphic	Soapstone
SPSL	Metamorphic	Spotted slate
STGN	Metamorphic	Staurolite gneiss
STSC	Metamorphic	Staurolite schist
SYGN	Metamorphic	Syenite gneiss
TASC	Metamorphic	Talc schist
TOHO	Metamorphic	Tourmaline hornfels
TOSC	Metamorphic	Tourmaline schist
TOMISC	Metamorphic	Tourmaline-mica schist
TRGN	Metamorphic	Trachyte gneiss
TRHO	Metamorphic	Tremolite hornfels
TRMA	Metamorphic	Tremolite marble
ULTR	Metamorphic	Ultramylonite
WOHO	Metamorphic	Wollastonite hornfels
WOMA	Metamorphic	Wollastonite marble

Secondary code	Primary lithology	Secondary lithology
AGGL	Sedimentary	Agglomerate
ANHY	Sedimentary	Anhydrite
ARGI	Sedimentary	Argillite
ARKO	Sedimentary	Arkose
ARAR	Sedimentary	Arkose argillaceous
ARCA	Sedimentary	Arkose calcareous
ARSI	Sedimentary	Arkose siliceous
ASPH	Sedimentary	Asphalt
BENT	Sedimentary	Bentonite
BREC	Sedimentary	Breccia
CALI	Sedimentary	Caliche
CHAL	Sedimentary	Chalk
CHER	Sedimentary	Chert
CHOO	Sedimentary	Chert oolitic
CLAS	Sedimentary	Claystone
CLSI	Sedimentary	Claystone siliceous
COAN	Sedimentary	Coal, anthracite
COBI	Sedimentary	Coal, bituminous
CONG	Sedimentary	Conglomerate
COQU	Sedimentary	Coquina
DIAT	Sedimentary	Diatomite
DOLO	Sedimentary	Dolomite
GILS	Sedimentary	Gilsonite
GRAY	Sedimentary	Graywacke
GRCA	Sedimentary	Graywacke calcareous
GRSA	Sedimentary	Greensand
GYPS	Sedimentary	Gypsum
HALI	Sedimentary	Halite
HEMA	Sedimentary	Hematite
INLISA	Sedimentary	Interbedded limestone and sandstone
INLISH	Sedimentary	Interbedded limestone and shale
INLISI	Sedimentary	Interbedded limestone and siltstone
INSASH	Sedimentary	Interbedded sandstone and shale
INSASI	Sedimentary	Interbedded sandstone and siltstone
IRON	Sedimentary	Ironstone

Secondary code	Primary lithology	Secondary lithology
LIGN	Sedimentary	Lignite
LIME	Sedimentary	Limestone
LIAN	Sedimentary	Limestone arenaceous
LIAR	Sedimentary	Limestone argillaceous
LIBI	Sedimentary	Limestone bituminous
LICR	Sedimentary	Limestone carbonaceous
LICH	Sedimentary	Limestone cherty
LICL	Sedimentary	Limestone clastic
LIFE	Sedimentary	Limestone iron-rich
LIOO	Sedimentary	Limestone oolitic
LIOR	Sedimentary	Limestone organic
LIPH	Sedimentary	Limestone phosphatic
LISI	Sedimentary	Limestone siliceous
LISICL	Sedimentary	Limestone siliciclastic
LIMO	Sedimentary	Limonite
MARLST	Sedimentary	Marlstone
MUDS	Sedimentary	Mudstone
MUSI	Sedimentary	Mudstone siliceous
OOCA	Sedimentary	Oolite calcareous
OOFE	Sedimentary	Oolite iron-rich
OOPH	Sedimentary	Oolite phosphatic
OOSI	Sedimentary	Oolite siliceous
ORTH	Sedimentary	Orthoquartzite
ORFS	Sedimentary	Orthoquartzite feldspathic
ORLI	Sedimentary	Orthoquartzite lithic
PHOS	Sedimentary	Phosphorite
PORC	Sedimentary	Porcellanite
RADI	Sedimentary	Radiolarite
ROSA	Sedimentary	Rock Salt
SANS	Sedimentary	Sandstone
SAAR	Sedimentary	Sandstone argillaceous
SAARFS	Sedimentary	Sandstone argillaceous feldspathic
SAARLI	Sedimentary	Sandstone argillaceous lithic
SAARQU	Sedimentary	Sandstone argillaceous quartz
SACA	Sedimentary	Sandstone calcareous
SACAFS	Sedimentary	Sandstone calcareous feldspathic
SACALI	Sedimentary	Sandstone calcareous lithic

Secondary code	Primary lithology	Secondary lithology
SACAQU	Sedimentary	Sandstone calcareous quartz
SACRQU	Sedimentary	Sandstone carbonaceous quartz
SAFS	Sedimentary	Sandstone feldspathic
SAFE	Sedimentary	Sandstone iron-rich
SAFEQU	Sedimentary	Sandstone iron-rich quartz
SALI	Sedimentary	Sandstone lithic
SAQU	Sedimentary	Sandstone quartz
SHAL	Sedimentary	Shale
SHBI	Sedimentary	Shale bituminous
SHCA	Sedimentary	Shale calcareous
SHCR	Sedimentary	Shale carbonaceous
SHFE	Sedimentary	Shale iron-rich
SHPH	Sedimentary	Shale phosphatic
SHSI	Sedimentary	Shale siliceous
SIDE	Sedimentary	Siderite
SILS	Sedimentary	Siltstone
SICA	Sedimentary	Siltstone calcareous
SICR	Sedimentary	Siltstone carbonaceous
SIFE	Sedimentary	Siltstone iron-rich
SUBG	Sedimentary	Subgraywacke
SUCA	Sedimentary	Subgraywacke calcareous
TRAV	Sedimentary	Travertine
TUFA	Sedimentary	Tufa
TUFF	Sedimentary	Tuff
VOBR	Sedimentary	Volcanic breccia
VOLC	Sedimentary	Volcaniclastic
MIEXME	Undifferentiated	Mixed extrusive and metamorphic
MIEXSE	Undifferentiated	Mixed extrusive and sedimentary
MIIG	Undifferentiated	Mixed igneous (extrusive & intrusive)
MIIGME	Undifferentiated	Mixed igneous and metamorphic
MIIGSE	Undifferentiated	Mixed igneous and sedimentary
MIINME	Undifferentiated	Mixed intrusive and metamorphic
MIINSE	Undifferentiated	Mixed intrusive and sedimentary
MIMESE	Undifferentiated	Mixed metamorphic and sedimentary

Secondary code	Primary lithology	Secondary lithology
ALLU	Unconsolidated	Alluvium
ASLO	Unconsolidated	Ash/loess mixture
CIND	Unconsolidated	Cinders
COLL	Unconsolidated	Colluvium
CRYO	Unconsolidated	Cryoturbate
DIAM	Unconsolidated	Diamicton
DIEA	Unconsolidated	Diatomaceous earth
EOLI	Unconsolidated	Eolian deposit
GLAC	Unconsolidated	Glacial deposit
GLMO	Unconsolidated	Glacial moraine deposit
GLTI	Unconsolidated	Glacial till deposit
GLFL	Unconsolidated	Glaciofluvial deposit
GLLA	Unconsolidated	Glaciolacustrine deposit
GLMA	Unconsolidated	Glaciomarine deposit
GRSA	Unconsolidated	Greensand
GYSA	Unconsolidated	Gypsum sand
HUCA	Unconsolidated	Human cause/constructed
LACU	Unconsolidated	Lacustrine sediments
LAHA	Unconsolidated	Lahar
LADE	Unconsolidated	Landslide deposit
MARI	Unconsolidated	Marine sediments
MARL	Unconsolidated	Marl
MIXE	Unconsolidated	Mixed
MUCK	Unconsolidated	Muck
ORGA	Unconsolidated	Organic deposits
PEAT	Unconsolidated	Peat
RESI	Unconsolidated	Residuum
TALU	Unconsolidated	Talus deposit
TEPH	Unconsolidated	Tephra (undifferentiated)
TRAN	Unconsolidated	Transitional marine/continental deposits
VOAS	Unconsolidated	Volcanic ash

Reference

U.S. Department of Agriculture (USDA), Forest Service. 2009. Site general: field guide. Washington, DC: U.S. Department of Agriculture, Forest Service, Rangeland Management Staff. 57 p.

Appendix 8. Landform

The landform list in the following table is based on Haskins et al. (1998).

Geomorphic term	Process/landform	Code
aa flow	Volcanic landform	AAFL
air-fall tephra field	Volcanic landform	AFTF
alluvial fan	Fluvial landform	ALFA
anticline	Tectonic landform	ANTI
avalanche talus	Mass wasting element landform	AVTA
backshore terrace	Coastal marine and lacustrine element landform	BATE
badlands	Landscape term and fluvial landform	BADL
bajada	Landscape term and fluvial landform	BAJA
bald	Common landform	BALD
bank	Fluvial landform	BANK
bar	Fluvial landform and microfeature	BAR
bay	Common landform	BAY
beach	Coastal marine and lacustrine landform	BEAC
beach ridge	Coastal marine and lacustrine element	BERI
beaver	Lacustrine subprocess	BEAV
bench	Common landform	BNCH
block field	Periglacial landform	BLFI
blowout	Common landform	BLOW
caldera	Volcanic landform	CALD
canyon	Landscape term	CANY
canyonlands	Landscape term	CALA
Carolina Bay	Coastal marine landform	CABA
channel	Fluvial landform and microfeature	CHAN
cinder cone	Volcanic landform	CICO
cirque	Glacial element landform	CIRQ
cliff	Common landform	CLIF
colluvial slope	Mass wasting element landform	COSL
crater	Volcanic landform	CRAT
cuesta	Fluvial landform	CUES
debris flow	Mass wasting landform	DEFL
deflation basin	Eolian landform	DEBA
delta	Fluvial landform and landscape term	DELT

Geomorphic term	Process/landform	Code
depositional stream terrace	Fluvial landform	DEST
depression	Common landform	DEPR
dike	Landform	DIKE
drainage channel (undifferentiated)	Glacial element landform	DRCH
draw	Common landform	DRAW
drumlin	Glacial landform	DRUM
earth flow	Mass wasting landform	EAFL
erosional stream terrace	Fluvial landform	ERST
escarpment	Common landform	ESCA
esker	Glacial landform	ESKE
fault scarp	Tectonic landform	FASC
fault trace	Tectonic landform	FATR
flood plain	Fluvial landform	FLPL
fold	Tectonic landform	FLDS
foredune	Eolian landform	FORE
frost action	Periglacial subprocess	FRAC
glaciated uplands	Landscape term	GLUP
gorge	Common landform	GORG
graben	Landscape term and tectonic landform	GRAB
ground moraine	Glacial landform	GRMO
gully	Common landform	GULL
hanging valley	Glacial landform	HAVA
hillslope bedrock outcrop	Mass wasting element landform	HIBO
hogback	Fluvial landform	HOGB
interdune flat	Eolian landform	INFL
interfluve	Common landform	INTE
intermontane basin	Landscape term	INBA
kame	Glacial landform	KAME
karst	Landscape term	KRST
kettle	Glacial element landform	KETT
kettled outwash plain	Glacial landform	KEOP
lahar	Volcanic landform	LAHA
lake	Lacustrine landform	LAKE
lake bed	Lacustrine landform	LABE

Geomorphic term	Process/landform	Code
lateral moraine	Glacial landform	LAMO
lava flow (undifferentiated)	Volcanic landform	LAFL
loess deposit (undifferentiated)	Eolian landform	LODE
meander scar	Fluvial element landform	MESR
medial moraine	Glacial landform	MEMO
mesa	Fluvial landform	MESA
monocline	Tectonic landform	MONO
moraine (undifferentiated)	Glacial landform	MORA
mud flat	Coastal marine landform	MUFL
outwash fan	Glacial landform	OUFA
outwash plain	Glacial landform	OUPL
outwash terrace	Glacial landform	OUTE
oxbow	Fluvial element landform	OXBO
pediment	Fluvial landform	PEDI
permafrost	Periglacial subprocess	PERM
point bar	Fluvial element landform	POBA
pyroclastic flow	Volcanic element landform	PYFL
recessional moraine	Glacial landform	REMO
ridgetop bedrock outcrop	Mass wasting element landform	RIBO
rock glacier	Mass wasting landform	ROGL
rock slide-rock fall	Mass wasting landform	RSRF
rotational slide	Mass wasting landform	ROSL
saddle	Common landform	SADD
sand boil	Microfeature	SABO
sandhills	Landscape term	SAND
scarp	Common landform	SCAR
seep	Common landform	SEEP
shield volcano	Volcanic landform	SHVO
sinkhole (undifferentiated)	Solution landform	SINK
slide	Mass wasting subprocess	SLID
slough	Common landform	SLOU
slump pond	Lacustrine landform	SLPO
solifluction lobe	Mass wasting landform	SOLO

Geomorphic term	Process/landform	Code
stream terrace (undifferentiated)	Fluvial landform	STTE
syncline	Tectonic landform	SYNC
talus	Common landform	TALU
tarn	Lacustrine landform	TARN
terminal moraine	Glacial landform	TEMO
till plain	Landscape term	TIPL
valley floor	Fluvial element landform	VAFO

Reference

Haskins, D.M.; Correll, C.S.; Foster, R.A.; et al. 1998. A geomorphic classification system. Washington, DC: U.S. Department of Agriculture, Forest Service. 110 p.

Appendix 9. Plant Labels (Cut Along Dashed Lines)

Plant (or unknown #): _____ Collection # _____ Date: _____

Site Name: _____ Project/Unit: _____ Collector: _____

Perennial: Y or N Spreading: Y or N Height (m): _____ forb/graminoid/shrub/tree/other

Genus, Family, Comments: _____

Plant (or unknown #): _____ Collection # _____ Date: _____

Site Name: _____ Project/Unit: _____ Collector: _____

Perennial: Y or N Spreading: Y or N Height (m): _____ forb/graminoid/shrub/tree/other

Genus, Family, Comments: _____

Plant (or unknown #): _____ Collection # _____ Date: _____

Site Name: _____ Project/Unit: _____ Collector: _____

Perennial: Y or N Spreading: Y or N Height (m): _____ forb/graminoid/shrub/tree/other

Genus, Family, Comments: _____

Plant (or unknown #): _____ Collection # _____ Date: _____

Site Name: _____ Project/Unit: _____ Collector: _____

Perennial: Y or N Spreading: Y or N Height (m): _____ forb/graminoid/shrub/tree/other

Genus, Family, Comments: _____

Plant (or unknown #): _____ Collection # _____ Date: _____

Site Name: _____ Project/Unit: _____ Collector: _____

Perennial: Y or N Spreading: Y or N Height (m): _____ forb/graminoid/shrub/tree/other

Genus, Family, Comments: _____

Appendix 10.

Measurement of Discharge at Springs and Wetlands

1. Introduction

Measurement of discharge at springs and wetlands, although similar to such measurements in streams, presents additional challenges. Each site is unique, so that a measurement method that may be appropriate at one site may not be appropriate at another site. The field investigator must evaluate each site and choose the appropriate method to use, and, if necessary, modify the method to adjust to conditions at the site. For example, if discharge at a spring or wetland site is diffuse or coming from several points, a channel might be dug to incorporate such diffuse flow into a single channel that can then be measured.

These instructions are modified from: Rantz et al. (1982). Additional information may be obtained from sources listed in the References section.

2. Purpose

This is a description of techniques for measurement of discharge at springs and in wetlands that have flowing waters. The situations and methodologies discussed include the following:

- Current meter.
- Timed observation of floats.
- Volumetric measurement.
- Use of a calibrated portable weir plate.
- Use of a calibrated portable Parshall flume.
- Static head change procedure.
- Visual estimate.

3. Key Scientific Concepts, Considerations, and Assumptions

Measuring the discharge of some springs and wetlands can be challenging because the amount of discharge is small, waters are usually shallow and broadly and unevenly spread over a wide area, and areas with moving water are sometimes limited. Multiple observations are recommended to quantify precisely the hydrologic period or long-term discharge characteristics, because discharge changes diurnally, seasonally, and annually.

The way the flow (or discharge) is measured will vary depending on the site-specific factors, therefore, a variety of methods are presented. Table 10.1 lists the various instruments recommended for a range of discharge conditions.

Table 10.1.—*Recommended methods to measure discharge based on flow (Stevens et al. 2006).*

Discharge (metric)	Discharge (gpm)	Instrument(s)
< 10 mL/s	< 0.16	Volumetric
10 to 100 mL/s	0.16 to 1.6	Weir, volumetric
0.1 to 1 L/s	1.6 to 16	Weir, flume
1 to 10 L/s	16 to 158	Weir, flume
10 to 100 L/s	158 to 1,585	Flume
0.1 to 1 m ³ /s	1,585 to 15,850	Current meter
1 to 10 m ³ /s	15,850 to 158,500	Current meter
> 10 m ³ /s	> 158,500	Current meter

Note: Of all of the instruments listed, the flume is the largest and most difficult to carry. Therefore, it should not be carried into the back country unless it is essential to obtain an accurate measurement or if the spring has a discharge magnitude making a flume the optimal instrument.

Hanging gardens and limnocrenes, in particular, present a challenge for measuring flow. Flow measurements at a hanging garden could be taken at the base of the wall where flow coalesces into a channel. If this is not possible, photo documentation of the wetted area of rock face is an option. For limnocrenes that do not have outflow, the static head change method is used. For limnocrenes that have an outflow, one of the other measurement techniques described in the following paragraphs would be appropriate.

If a single channel exists, the discharge measurement should be taken as close as possible to the spring orifice. If multiple channels exist, and if they all converge to a single channel, the discharge can be measured in the single channel as close as possible to the confluence of all of the multiple channels. Alternatively, the flow at each orifice can be measured.

3.1 Accuracy of Discharge Measurements

Accuracy of a discharge measurement is dependent on many factors, including the equipment used, the location and characteristic of the measuring section, the number and spacing of measurements, the rate of change in stage, the measurement depth and velocity, presence of ice and/or debris, wind, and (especially) the experience of the person conducting the measurement (Turnipseed and Sauer 2010, p. 79). The accuracy is often evaluated qualitatively, taking all of these factors into account.

See Rantz et al. (1982) and Turnipseed and Sauer (2010) for information on field equipment used for some of the methods described in the following section.

4. Procedure

4.1 Current Meter

A current meter is an instrument used to measure the velocity of flowing water at a specific point in a channel. Several types of current meters are now available. Selecting which meter to use at a site will depend on purpose, site conditions, and cost. Historically, the U.S. Geological Survey (USGS) has used vertical-axis current meters (price current meter), which are mechanical devices that use spinning cups to measure the current velocity (Rantz et al. 1982 pp. 86–88). A smaller version (pygmy meter) is used at sites where water is shallow, such as a spring or wetland. Advancements in acoustic technology have led to important developments in the use of acoustic Doppler current profilers, acoustic Doppler velocimeters, and other emerging technologies for the measurement of discharge. These new instruments, based on acoustic Doppler theory, have the advantage of no moving parts, and in the case of the acoustic Doppler current profiler, quickly and easily provide three-dimensional stream-velocity profile data through much of the vertical water column. Additional information on current USGS stream-gaging procedures, including

information on use of electronic field notebooks and personal digital assistants (PDAs), is available in Turnipseed and Sauer (2010).

Current meters are necessary in springs or in wide channels or high-discharge channels where flow cannot be routed into a weir or a flume. Measurement locations are selected in a straight reach where the streambed is free of large rocks, weeds, and protruding obstructions that create turbulence and where a flat streambed profile occurs to eliminate vertical components of velocity.

The cross-section of the channel is divided into partial sections, and the area and mean velocity of each section is measured separately. A partial section is a rectangular region in which depth is equal to the depth measured at that location, and for which width is equal to the sum of half the distances of adjacent verticals. At each vertical, the following observations are recorded on the data sheet: (1) the distance to a reference point on the bank along the tag line, (2) the depth of flow, and (3) the velocity as indicated by the current meter. The velocity should be measured at a depth that is 0.6 of the depth from the surface of water in the channel. The discharge of each partial section is calculated as the product of mean velocity times depth at the vertical times the sum of half the distances to adjacent verticals. The sum of the discharges of each partial section is the total discharge.

Measurements are made by wading in the stream with the current meter along the tag line. The person wading the channel should stand downstream of the velocity meter. Detailed procedures for use of current meters is documented in Rantz et al. (1982) and Turnipseed and Sauer (2010).

Accuracy of current-meter measurements can be evaluated using methods described by Sauer and Meyer (1992). Their study indicated that accuracy can range from 2-percent measurement error under ideal measurement conditions to 20-percent measurement error under poor conditions. Under generally normal conditions, standard errors of measurement range from 3 to 6 percent.

4.2 Float Method

Floats are useful for measuring discharges at springs and wetlands, where water is shallow and velocities may be too small to accurately use a current meter. Floats can be almost any

distinguishable article that floats, such as wooden disks; bottles partly filled with water, soil, or stones; or oranges. Floating ice cakes or distinguishable pieces of drift may be used if they are present in the stream. Fluorescent dye can also be used.

Two cross-sections are selected along a reach of straight channel for a float measurement. The cross-sections should be far enough apart so that the time the float takes to pass from one cross-section to the other can be measured accurately. A travel time of at least 20 seconds is recommended, but a shorter time may be used for streams with such high velocities that it is not possible to find a straight reach of channel having adequate length. The distance between the two sections is measured with a measuring tape, and recorded. The width and depth of each channel cross-section is measured with a tape measure and recorded. In making a float measurement, the float is introduced a short distance upstream from the upstream cross-section so that it will be traveling at the speed of the current when it reaches the upstream section. A stopwatch is used to time its travel between the end cross-sections of the reach. This procedure is repeated 3 to 5 times, as the float is placed at different locations across the channel at the upstream cross-section. The average velocity of the measurement is then calculated. An example field sheet for use with this method is shown in table 10.2.

The velocity of the float is equal to the distance between the end cross-sections divided by the time of travel. The mean velocity in the vertical is equal to the float velocity multiplied by a coefficient whose value is dependent on the shape of the vertical-velocity profile of the stream, and on the depth of immersion of the float with respect to stream depth. Coefficients of 0.85 to 0.88 are commonly used to convert the velocity of a surface float to mean velocity in the vertical (Turnipseed and Sauer 2010, p. 85).

The procedure for computing the discharge is similar to that used in computing the discharge for a conventional current-meter measurement. Discharge is computed by multiplying the area of the channel by the mean vertical velocity.

Float measurements of discharge that are carefully made under favorable conditions may be accurate to within +/- 10 percent. Wind may adversely affect the accuracy of the computed discharge due to its effect on the velocity of the floats. If a non-uniform reach is selected, measurement results may be in error by as much as 25 percent.

Table 10.2.—*Example field sheet for use with the float method.*

Float method		
Reach length:		
Trial	Time elapsed	Velocity (reach length/time)
#1		
#2		
#3		
Average velocity:		
Average velocity x 0.85:		

4.3 Volumetric Measurement

The volumetric measurement of discharge is the most accurate method of measuring small flows (less than a few gallons per minute). The time required to fill a container of known capacity, or the time required to partly fill a calibrated container to a known volume, is recorded. The only equipment required, other than the calibrated container, is a stopwatch.

Volumetric measurements are usually made where the flow is concentrated in a narrow stream, or can be so concentrated, so that all the flow may be diverted into a container. Examples of sites presenting the opportunity for volumetric measurement of discharge are a V-notch weir, a natural or artificial control where all the flow is confined to a notch; or a cross section of natural channel where a temporary earth dam can be built over a pipe of small diameter, through which the entire flow is directed. Sometimes it is necessary to place a trough against the artificial control to carry the water from the control to the calibrated container. If a small temporary dam is built, the stage behind the dam should be allowed to stabilize before the measurement is begun. The measurement should be made three or four times to be certain no errors have been made and to be sure the results are consistent. Several calibrated containers of varying sizes should be taken to the field site.

4.4 Portable Weir Plate

A portable weir plate is useful for determining discharge when depths are too shallow and velocities too low for a reliable current-meter measurement of discharge. A 90-degree V-notch

weir is particularly suitable because of its sensitivity at low flows. The USGS commonly uses three different sizes of weir plate; their recommended dimensions are given in figure 10.1.

The weir plate is made of galvanized sheet iron, using 10- to 16-gauge metal. The 90-degree V-notch that is cut in the plate is not beveled but is left with flat, even edges. A staff gage, attached to the upstream side of the weir plate with its zero at the elevation of the bottom of the notch, is used to read the head on the weir. The staff gage should be installed far enough from the notch to be outside the region of drawdown of water going through the notch. Drawdown becomes negligible at a distance from the vertex of the notch that is equal to twice the head on the notch. Consequently, if the weir plate has the dimensions recommended in figure 10.1, the staff gage should be installed near one end of the plate.

Figure 10.1.—Portable weir plate sizes.

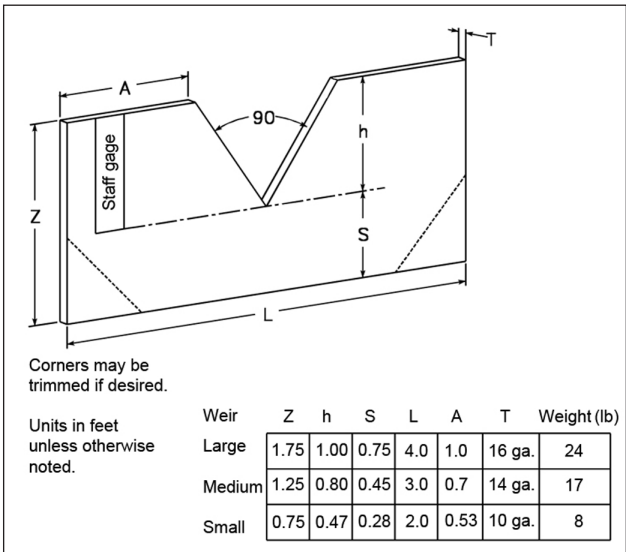

To install the weir, the weir plate is pushed into the streambed. A pick or shovel may be necessary to remove stones or rocks that prevent even penetration of the plate. A carpenter's level is used to ensure that the top of the plate is horizontal and that the face of the plate is vertical. Soil or streambed material is packed around the weir plate to prevent leakage under and around it. It ordinarily requires only one person to make the installation.

A large weir plate of the dimensions shown in figure 10.1 can measure discharges in the range from 0.02 to 2.0 ft³/s (0.00057 to 0.057 m³/s) with an accuracy of +/- 3 percent, if the weir is not submerged. A weir is not submerged when air circulates freely around all sides of the nappe. The general equation for flow over a sharp-edged 90-degree V-notch weir is

$$Q = Ch^{5/2}$$

where

Q = discharge, in cubic feet per second or cubic meters per second,

h = static head above the bottom of the notch, in feet or meters,

C = coefficient of discharge.

Each weir should be rated to determine C by volumetrically measuring the discharge corresponding to various values of head. In the absence of such a rating, a value of 2.47 may be used for C when British units are used, or 1.36 when metric units are used.

When the weir is installed, it will cause a pool to form on the upstream side of the plate. No readings of head on the notch should be recorded until the pool has risen to a stable elevation. The head should then be read at half-minute intervals for about 3 minutes, and the mean value of those readings should be used as the value for head in the equation to compute discharge. After the completion of the measurement, the weir plate is removed.

An online method for calculating discharge using a V-notch weir is available at <http://www.lmnoeng.com/Weirs/vweir.htm>.

4.3 Portable Parshall Flume

A portable Parshall flume is another device for determining discharge when depths are too shallow and velocities too low for a current-meter measurement of discharge. The portable flume used by the USGS is a modified form of the standard Parshall flume having a 3-inch (0.076 meter) throat. The modification consists, primarily, of the removal of the downstream diverging section of the standard flume. The purpose of the modification is to reduce the weight of the flume and to make it easier to install.

Because the portable Parshall flume has no downstream diverging section, it cannot be used for measuring flows when the submergence ratio exceeds 0.6. The submergence ratio is the ratio of the downstream head on the throat to the upstream head on the throat. Although a submergence ratio of 0.6 can be tolerated without affecting the rating of the portable flume, in practice the flume is usually installed so that the flow freely passes the throat without being slowed by ponding below the flume. That installation is usually accomplished by building up the streambed a couple of inches under the level converging floor of the flume. Figure 10.2 shows the plan and elevation of the portable Parshall flume. The gage height or upstream head on the throat is read in the small stilling well that is hydraulically connected to the flow by a 3/8-inch hole. The rating for the flume is given in table 10.3.

When the flume is installed in the channel, the floor of the converging section is set in a level position by using the level bubble that is attached to one of the braces (fig. 10.2). A carpenter's level can be used for that purpose if the flume is not equipped with a level bubble. Soil or streambed material is then packed around the flume to prevent leakage under and around it. After the flume is installed, water will pool upstream from the structure. No gage-height readings should be recorded until the pool has risen to a stable level. As with the portable weir, after stabilization of the pool level, gage-height readings should be taken at 30-second intervals for about 3 minutes. The mean value of those readings is the gage height used in table 10.3 to obtain the discharge. A carefully made measurement should have an accuracy of +/- 2 or 3 percent. After completion of the measurement, the portable flume is removed.

Figure 10.2.—Working drawing of modified 3-inch Parshall flume.

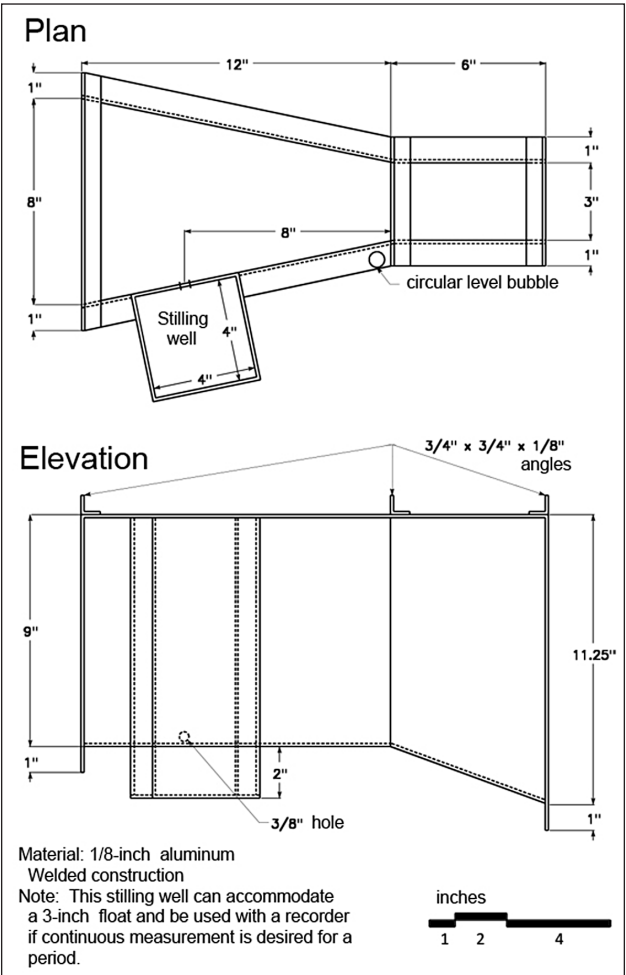

Table 10.3.—Rating table for 3-inch modified Parshall flume.

Gage height (ft)	Discharge (ft ³ /s)	Gage height (ft)	Discharge (ft ³ /s)	Gage height (ft)	Discharge (ft ³ /s)
0.01	0.0008	0.21	0.097	0.41	0.280
0.02	0.0024	0.22	0.104	0.42	0.290
0.03	0.0045	0.23	0.111	0.43	0.301
0.04	0.0070	0.24	0.119	0.44	0.312
0.05	0.010	0.25	0.127	0.45	0.323
0.06	0.013	0.26	0.135	0.46	0.334
0.07	0.017	0.27	0.144	0.47	0.345
0.08	0.021	0.28	0.153	0.48	0.357
0.09	0.025	0.29	0.162	0.49	0.368
0.10	0.030	0.30	0.170	0.50	0.380
0.11	0.035	0.31	0.179	0.51	0.392
0.12	0.040	0.32	0.188	0.52	0.404
0.13	0.045	0.33	0.198	0.53	0.417
0.14	0.051	0.34	0.208	0.54	0.430
0.15	0.057	0.35	0.218	0.55	0.443
0.16	0.063	0.36	0.228	0.56	0.456
0.17	0.069	0.37	0.238	0.57	0.470
0.18	0.076	0.38	0.248	0.58	0.483
0.19	0.083	0.39	0.259	0.59	0.497
0.20	0.090	0.40	0.269		

4.6 The Static Head Change Procedure

This method may be used for a relative comparison value for change in elevation of standing pools or limnocrenes with no outflow. A staff gage is placed in the standing pool and relative gage elevation recorded, or efforts are made to locate and record an existing fixed point in or near the standing pool and the vertical distance to the pool surface recorded. Periodic measurements of changes in the static head on the staff gage or fixed point are recorded.

4.7 Visual Estimate

Site conditions, such as dense vegetation cover, steep or flat slope, diffuse discharge into a marshy area, and limited or dangerous access sometimes do not allow for a direct measurement of discharge by the techniques listed previously. Typically, the visual estimate method is used along with a gross estimate of flow velocity with a float but is only recommended as a last resort. Discharge class is estimated based on those listed in table 10.1. Photographs should be taken to record the surface area wetted or covered by water and observations recorded on a datasheet. Also, it should be noted if another method could be recommended to measure discharge for future site visits.

5. Documentation and Data Management

The name, serial number (if available), accuracy of the instrument used to measure discharge, and any other important observations should be recorded. Important observations may include the markers of any recent high discharges, such as high water marks, oriented vegetation, or debris on or above the channel or floodplain.

All computation sheets for discharge calculations should be neat and legible. Errors or modifications should be indicated by a single line drawn through them (no erasures or blackouts). These computations should be checked by an independent reviewer. Copies of computation sheets should be kept in project files and archived according to required procedures. Electronic copies of computations should be archived in the appropriate database.

6. Additional Information

American Society for Testing and Materials. 2007. Standard test method for open-channel flow measurement of water with thin-plate weirs. ASTM D5242 - 92(2007). West Conshohocken, PA. <http://www.astm.org/Standards/D5242.htm>. (21 November 2011).

Desert Managers Group. 2001. Protocol for hydrologic data to be collected at desert wetland sites by BLM and NPS personnel in support of the California DMG water study. 4 p. http://www.dmg.gov/documents/PRT_Springs_Data_Collection_DMG_052401.pdf. (21 November 2011).

International Organization of Standards. 1980. Water flow measurement in open channels using weirs and venturi flumes—Part 1: thin plate weirs. ISO 1438/1-1980(E). <http://global.ihc.com>. (21 November 2011).

Oberg, K.A.; Morlock, S.E.; and Caldwell, W.S. 2005. Quality-assurance plan for discharge measurements using acoustic Doppler current profilers. U.S. Geological Survey Scientific Investigations Report 2005-5183. 35 p. <http://pubs.usgs.gov/sir/2005/5183>. (21 November 2011).

U.S. Department of the Interior, Bureau of Reclamation. 1997. Water measurement manual. 3rd ed. http://www.usbr.gov/pmts/hydraulics_lab/pubs/wmm/index.htm. (21 November 2011).

7. References

Rantz, S.E. et al. 1982. Measurement of stage and discharge. In: Measurement and computation of streamflow: volume 1. U.S. Geological Survey, water supply paper 2175. 313 p. <http://pubs.usgs.gov/wsp/wsp2175/>. (21 November 2011).

Sauer, V.B.; Meyer, R.W. 1992. Determination of error in individual discharge measurements. U.S. Geological Survey Open-File Report 92-144. 21 p. <http://water.usgs.gov/software/MEASERR>. (21 November 2011).

Stevens, L.; Kloeppe, H.; Springer, A.; Sada, D. 2006. Terrestrial springs ecosystems inventory protocols. Cooperative Agreement Number CA 1200-99-009, TASK# NAU-118. Flagstaff, AZ: National Park Service. 45 p.

Turnipseed, D.P.; Sauer, V.B. 2010. Discharge measurements at gaging stations. In: U.S. Geological Survey techniques and methods, book 3, chap. A8. 87 p. <http://pubs.usgs.gov/tm/tm3-a8>. (21 November 2011).

Appendix 11. Identification of Freshwater Invertebrates

This appendix has representative drawings of groups of aquatic macroinvertebrates important in springs and other groundwater-dependent ecosystems. A substantial amount of training is needed to identify many macroinvertebrate species, but identifying most groups (such as order or family) and many nonnative species may be accomplished with minimal training. These descriptions and illustrations can facilitate identification of important taxa in the field. Useful references that provide more detail include *A Guide to Common Freshwater Invertebrates of North America* (Voshell 2002) and *Aquatic Entomology: The Fisherman's and Ecologist's Illustrated Guide to Insects and Their Relatives* (McCafferty 1981). At the end of this appendix is a "Key to Macroinvertebrate Life in the River," developed by the University of Wisconsin, in an easy-to-use flowchart format.

The following illustrations, other than those in the "Key to Macroinvertebrate Life in the River," were drawn by Luke Boehnke.

All three insect orders described in 11.1 to 11.6 leave the water to mate as winged adults. Large swarms of mating mayflies and caddisflies often occur when all the individuals of a single species emerge at the same time. The females of all three groups fly upstream and drop their eggs onto the water or dive into the stream to attach them to rocks or leaves.

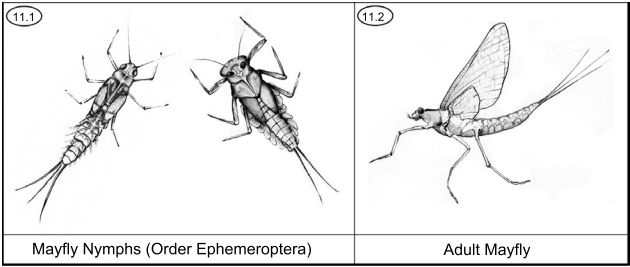

11.1-11.2. Mayflies are insects that spend most of their lives in streams, emerging briefly as adults to mate and lay eggs. Many species have gills that are visible along the abdomen. Most mayflies have three tails, but some have only two tails. Mayfly diversity declines as aquatic conditions are degraded; mayflies are particularly sensitive to mine waste. (Size: 6 to 25 millimeters)

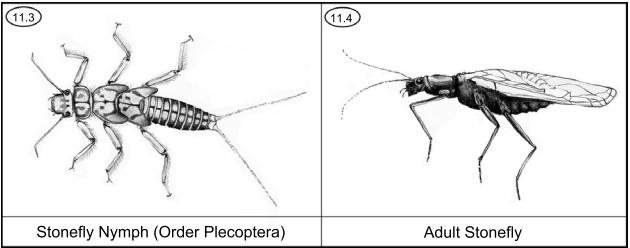

11.3-11.4. Stonefly nymphs are almost always found in flowing water. Some stoneflies feed on other invertebrates while other taxa eat dead organic matter and have a preference for coarse substrate. Stoneflies look similar to mayflies but are stockier, have two claws (rather than one) on each foot, and have two tails instead of the usual three in mayflies. There are no gills on the abdomen. Diversity of these animals declines rapidly at the first sign of human disturbance. (Size: 12 to 40 millimeters)

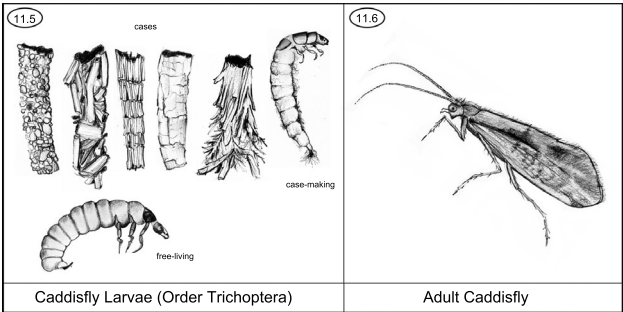

11.5-11.6. Caddisflies are insects that emerge to mate as winged adults. They use silk to build cases from gravel, twigs, needles, or sand. The larva is caterpillar-like with three pairs of legs, two claws at the posterior (rear) end of the abdomen, and a tendency to curl up slightly. They may be found in a stick, rock, or leaf case, with the head sticking out. Different species build distinct cases or chambers, often on or under rocks. Free-living caddisfly larvae do not build cases; many are predators and need to move quickly to capture other animals for food. Some caddisflies are very sensitive to human disturbance, but others are tolerant. (Size: 12 to 40 millimeters)

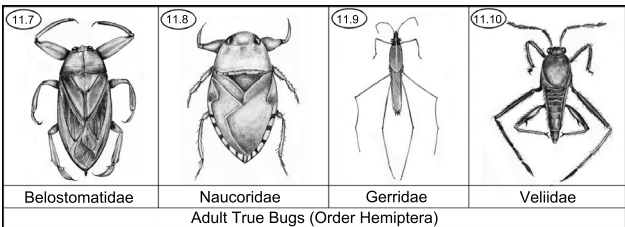

11.7-11.10. These four families of true bugs commonly occur in western North American springs. True bug larvae look similar to the adults. They can be distinguished from other aquatic insects by the following combination of characteristics: mouthparts are an elongated beak that folds back under the head when not feeding, wingpads are present on the thorax, three pairs of segmented legs with two claws on some of them, and no gills are present.

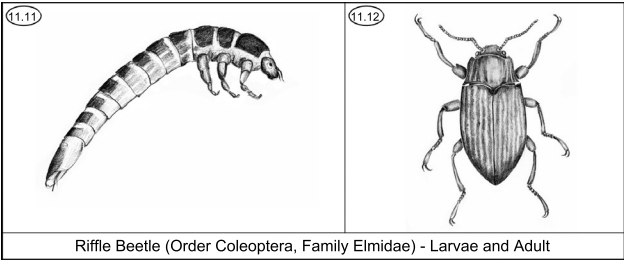

11.11-11.12. Riffle beetle larvae are specially adapted to cling to smooth rocks in fast-flowing water (riffles). After emergence, adults fly for a short time but return to water to feed in the same habitat as the larvae. Both larvae and adults are rather small and tend to drift to the bottom of a sample. Many beetle families occur in aquatic habitats, but comparatively few crenobiontic species exist. In the Western United States, most crenobiontic riffle beetles are in two genera, *Stenelmis* and *Microcylloepus*. Differentiating between these genera is difficult in the field because individuals are small (less than 3 millimeters long) and difficult to examine without magnification. They are easy to see in samples, however. Riffle beetles are black or dark brown with long, spindly legs. They move slowly by crawling, and they have weak swimming ability. (Size: less than 3 millimeters)

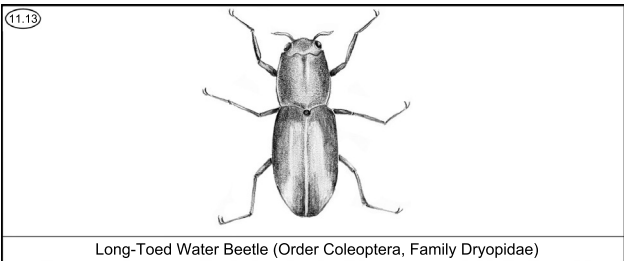

11.13. Long-toed water beetles are common in riffles and on woody debris or rocks. Adults use long, sharp claws to cling to debris and sometimes they crawl on the bottom or along the shore. The body is dull gray or brown and often covered with fine hairs, and the head is mostly withdrawn into the thorax. (Size: 4 to 8 millimeters)

11.14

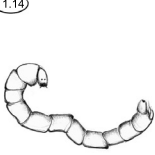

Chironomidae



Larva



Pupa

Simuliidae

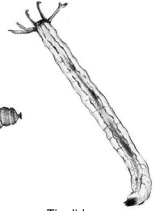

Tipulidae

Fly Larvae (Order Diptera)

11.14. Many species of true flies exist, but in springs, there are three main groups or families. Midge larvae (or chironomids) are very small (up to 6 millimeters), often C-shaped, with a segmented body and a spastic squirming movement. They are often whitish to clear, but occasionally bright red. Midge larvae have distinct heads with two small prolegs in the front of the body and are often attached to debris by their tiny legs. Blackfly larvae (or simuliids) are dumb-bell shaped and soft (up to 6 millimeters). The body is larger at the rear end, similar to the shape of a bowling pin. The distinct head contains fan-like mouth brushes. Blackfly larvae often curl into a “u” shape when held in your hand. They attach themselves to the stable substrate such as rocks, large wood, or rooted vegetation. Crane fly larvae (or tipulids) are large (8 to 60 millimeters) with a fleshy, worm-like, segmented body with finger-like projections (gills) at the back end. They occur in a variety of colors (clear, white, brown, and green) and bury themselves in soft sediment.

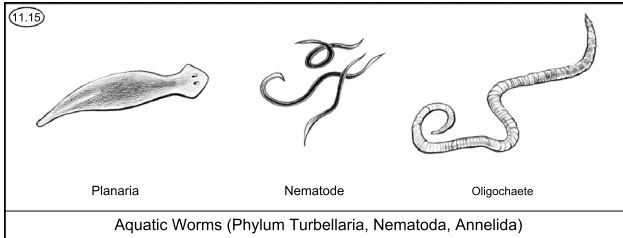

11.15. Flatworms (e.g., *Planaria*), roundworms (nematodes), and freshwater segmented worms (oligochaetes, leeches, earthworms) are properly called worms, but should not be confused with the soft-bodied larvae of flies. Nematodes and oligochaetes are long, thin, and writhe like snakes, while planarians glide. These animals do not have legs.

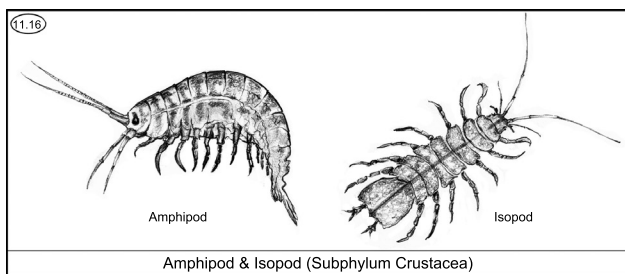

11.16. Amphipods (or scuds) occur in many springs and are usually very numerous. They are comparatively large (up to 10 millimeters long), active, and easy to identify in a macroinvertebrate sample. Amphipods are very fast swimmers that look like shrimp. They have many appendages that give them a fuzzy appearance. Amphipods can be common in very degraded sites. Isopods (or sowbugs) are usually found creeping through leaf litter. They have a flat, segmented body (6 to 20 millimeters) with an “armored” appearance and seven pairs of legs. Unlike amphipods, isopods are flattened top to bottom.

11.17

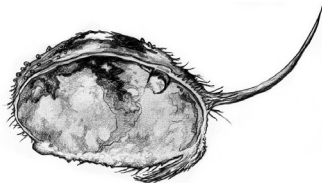

Ostracod (Subphylum Crustacea, Class Ostracoda)

11.17. Ostracods (seed shrimp) are the oldest known microfauna and have been extensively used in paleoclimate studies. They are small (usually less than 2 millimeters long), flattened animals with a calcitic shell and an external morphology that is similar to a plant seed. They are brown to pale olive green or gray, active, and are usually easy to see in a sample because they constantly move. Ostracods may occur in the water column or on the substrate, and they are usually abundant in springs.

11.18

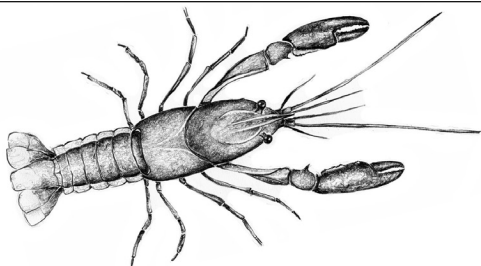

Crayfish (Subphylum Crustacea, Order Decapoda)

11.18. Crayfish generally occur only in large springs that do not dry. In some places, nonnative crayfish have been introduced into springs, with often dramatic negative effects on native plants and animals.

11.19

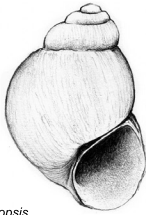
*Pyrgulopsis*

11.20

*Tryonia*

Springsnails (Phylum Mollusca, Class Gastropoda, Family Hydrobiidae)

11.19-11.20. Springsnails are small, black or brown crenobiontic species that have an operculum (lid) and a shell that opens on the right. Most species in southern U.S. deserts are in the genera *Pyrgulopsis* or *Tryonia*, which occur in two general body forms. Most *Pyrgulopsis* species are round and slightly inflated, while most *Tryonia* species are elongated. *Pyrgulopsis* species generally occur on gravel and cobble substrates and on watercress in areas with higher water velocity. *Tryonia* species are usually found in slow currents with fine substrates. (Size: less than 5 millimeters)

11.21



Physid Snail (Phylum Mollusca, Class Gastropoda, Family Physidae)

11.21. Physid snails are found in springs and, although some are introduced, many are native and likely endemic. There is no operculum, and the shell opens on the left. (Size: 5 to 20 millimeters)

11.22



Fingernail Clams (Phylum Mollusca, Class Bivalvia, Family Sphaeriidae)

11.22. Fingernail clams are small and usually bury themselves in habitats with fine sediment and low current velocity. They may be tan colored, but they are usually white and often translucent. Magnification is needed to differentiate species, which precludes field identification of species. When present, they are usually common and comparatively easy to find. (Size: 2 to 5 millimeters wide)

11.23

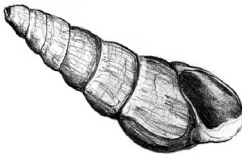

Red-rimmed Melania (Phylum Mollusca, Class Gastropoda, Family Thiariidae)

11.23. Red-rimmed melania (*Melanooides tuberculata*) is a mollusk that was introduced into North America from Asia by the aquarium trade and has become widespread throughout the Western United States. It is parthenogenic (reproduces asexually) and can survive long periods out of water. It can be easily transplanted, is tolerant of harsh conditions, and prefers warm, slow water and fine substrates. Red-rimmed melania is easy to identify by its distinctive shape and color. It is long and conical, with body whorls terminating at a sharp point. Its shell is slightly sculptured and its coloration is an attractive and distinct mottled, reticulated mixture of tan and brown. Because these mollusks are easily transported, care should be taken to completely clean and inspect field gear to ensure they are not carried and introduced into other springs. (Size: up to 25 millimeters)

References

McCafferty, W.P. 1981. Aquatic entomology: the fisherman's and ecologist's illustrated guide to insects and their relatives. Boston, MA: Science Book International. 448 p.

Voshell, J.R., 2002. A guide to common freshwater invertebrates of North America. Blacksburg, VA: McDonald and Woodward Publishing Co. 442 p.

